

HIGH VOLTAGE FAST-SWITCHING NPN POWER TRANSISTOR

- SGS-THOMSON PREFERRED SALESTYPE
- HIGH VOLTAGE CAPABILITY
- U.L. RECOGNISED ISOWATT218 PACKAGE (U.L. FILE # E81734 (N)).

APPLICATIONS:

- HORIZONTAL DEFLECTION FOR COLOUR TV

DESCRIPTION

The S2000AFI is manufactured using Multiepitaxial Mesa technology for cost-effective high performance and uses a Hollow Emitter structure to enhance switching speeds.

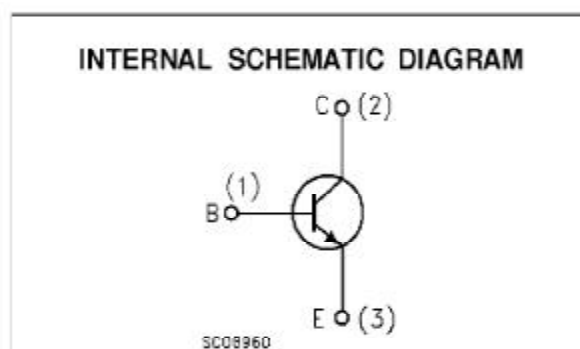
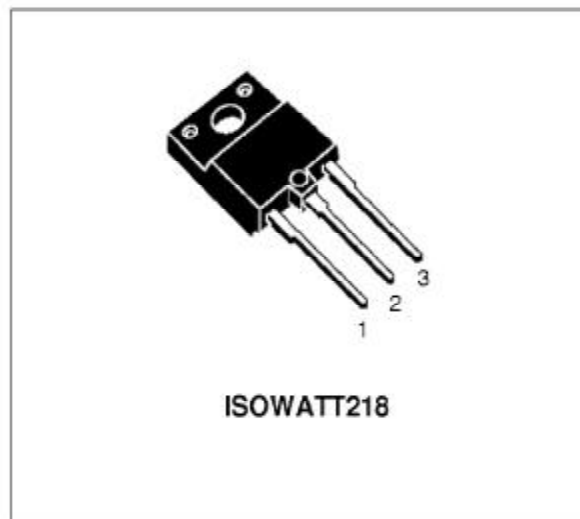

ABSOLUTE MAXIMUM RATINGS

Symbol	Parameter	Value	Unit
V_{CES}	Collector-Emitter Voltage ($V_{BE} = 0$)	1500	V
V_{CEO}	Collector-Emitter Voltage ($I_B = 0$)	700	V
V_{EBO}	Emitter-Base Voltage ($I_C = 0$)	10	V
I_C	Collector Current	8	A
I_{CM}	Collector Peak Current ($t_p < 5$ ms)	15	A
P_{tot}	Total Dissipation at $T_C = 25$ °C	50	W
T_{stg}	Storage Temperature	-65 to 150	°C
T_J	Max. Operating Junction Temperature	150	°C

THERMAL DATA

$R_{th(j-case)}$	Thermal Resistance Junction-case	Max	2.5	$^{\circ}C/W$
------------------	----------------------------------	-----	-----	---------------

ELECTRICAL CHARACTERISTICS ($T_{case} = 25^{\circ}C$ unless otherwise specified)

Symbol	Parameter	Test Conditions	Min.	Typ.	Max.	Unit
I_{CES}	Collector Cut-off Current ($V_{BE} = 0$)	$V_{CE} = 1500 V$ $V_{CE} = 1500 V$			1 2	mA mA
I_{EBO}	Emitter Cut-off Current ($I_C = 0$)	$V_{EB} = 5 V$			100	μA
$V_{CEO(sus)}$	Collector-Emitter Sustaining Voltage	$I_C = 100 mA$	700			V
V_{EBO}	Emitter Base Voltage ($I_C = 0$)	$I_E = 10 mA$	10			V
$V_{CE(sat)*}$	Collector-Emitter Saturation Voltage	$I_C = 4.5 A$ $I_B = 2 A$			1	V
$V_{BE(sat)*}$	Base-Emitter Saturation Voltage	$I_C = 4.5 A$ $I_B = 2 A$			1.3	V
t_s t_f	INDUCTIVE LOAD Storage Time Fall Time	$I_C = 4.5 A$ $h_{FE} = 2.5$ $V_{CC} = 140 V$ $L_C = 0.9 mH$ $L_B = 3 \mu H$		7 0.55		μs μs
f_T	Transition Frequency	$I_C = 0.1 A$ $V_{CE} = 5 V$ $f = 5 MHz$		7		MHz

* Pulsed: Pulse duration = 300 μs , duty cycle 1.5 %

Safe Operating Area.

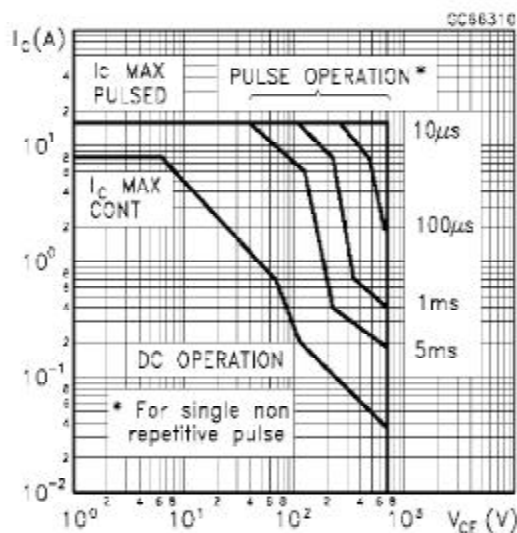

Thermal Impedance

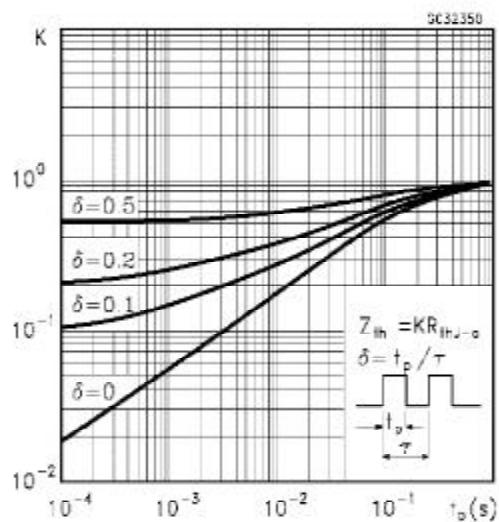

DC Current Gain

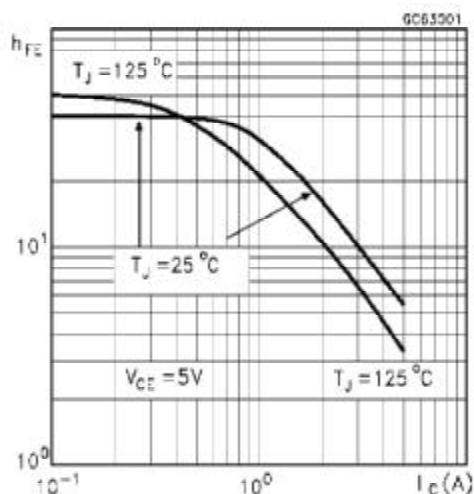

Collector Emitter Saturation Voltage

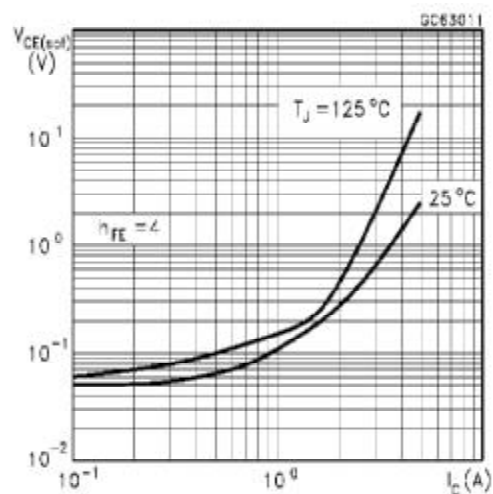

Base Emitter Saturation Voltage

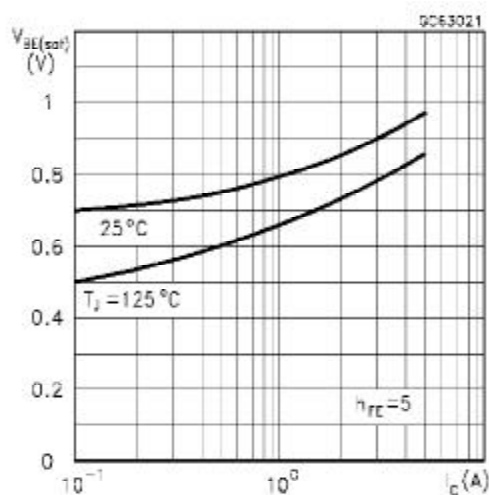

Switching Time Inductive Load

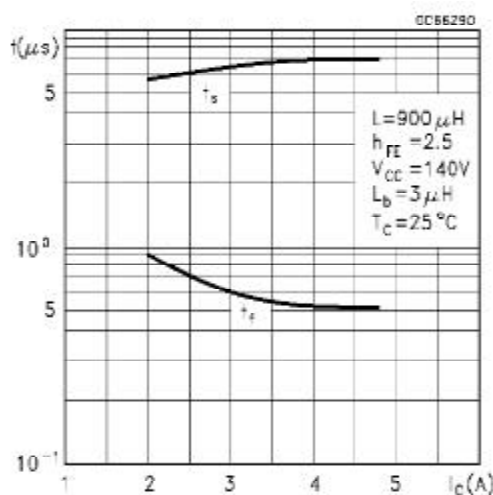

Switching Time Inductive Load (see figure 1)

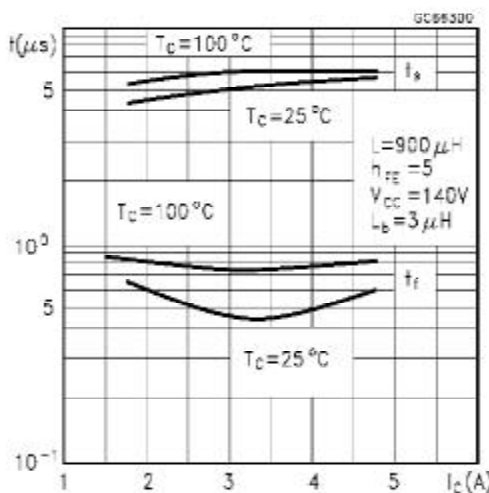
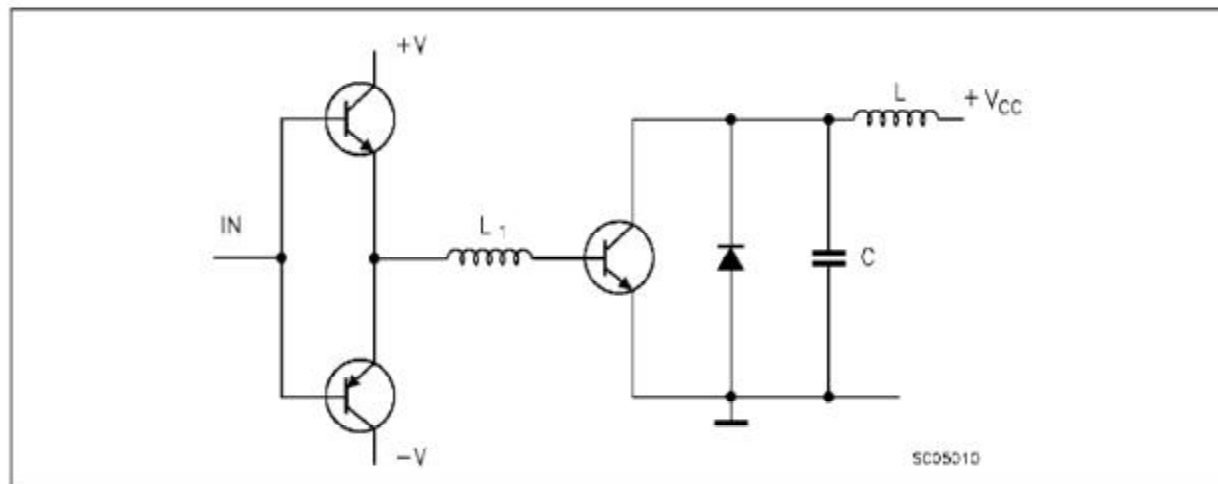
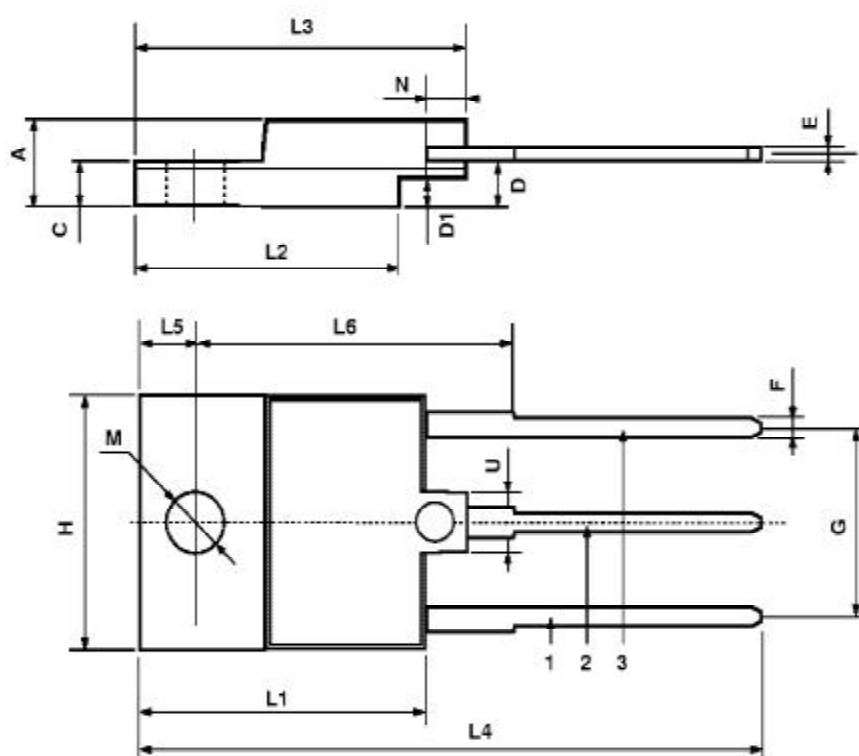

Figure 1: Inductive Load Switching Test Circuit.



ISOWATT218 MECHANICAL DATA

DIM.	mm			inch		
	MIN.	TYP.	MAX.	MIN.	TYP.	MAX.
A	5.35		5.65	0.210		0.222
C	3.3		3.8	0.130		0.149
D	2.9		3.1	0.114		0.122
D1	1.88		2.08	0.074		0.081
E	0.75		1	0.029		0.039
F	1.05		1.25	0.041		0.049
G	10.8		11.2	0.425		0.441
H	15.8		16.2	0.622		0.637
L1	20.8		21.2	0.818		0.834
L2	19.1		19.9	0.752		0.783
L3	22.8		23.6	0.897		0.929
L4	40.5		42.5	1.594		1.673
L5	4.85		5.25	0.190		0.206
L6	20.25		20.75	0.797		0.817
M	3.5		3.7	0.137		0.145
N	2.1		2.3	0.082		0.090
U		4.6			0.181	



P025C