

HEXFET® Power MOSFET

- Dynamic dv/dt Rating
- P-Channel
- Fast Switching
- Ease of Paralleling
- Simple Drive Requirements

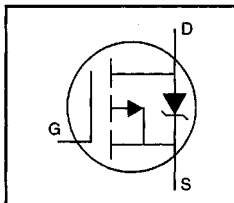

$$V_{DSS} = -200V$$

$$R_{DS(on)} = 3.0\Omega$$

$$I_D = -1.8A$$

Description

The HEXFET technology is the key to International Rectifier's advanced line of power MOSFET transistors. The efficient geometry and unique processing of the HEXFET design achieve very low on-state resistance combined with high transconductance and extreme device ruggedness.

The TO-220 package is universally preferred for all commercial-industrial applications at power dissipation levels to approximately 50 watts. The low thermal resistance and low package cost of the TO-220 contribute to its wide acceptance throughout the industry.

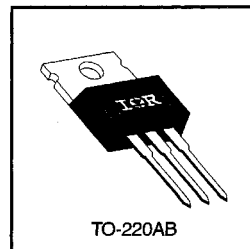

DATA SHEETS

Absolute Maximum Ratings

| | Parameter | Max. | Units |
|---------------------------|--|-----------------------|-------|
| $I_D @ T_C = 25^\circ C$ | Continuous Drain Current, $V_{GS} @ -10 V$ | -1.8 | A |
| $I_D @ T_C = 100^\circ C$ | Continuous Drain Current, $V_{GS} @ -10 V$ | -1.0 | |
| I_{DM} | Pulsed Drain Current ① | -7.0 | |
| $P_D @ T_C = 25^\circ C$ | Power Dissipation | 20 | W |
| | Linear Derating Factor | 0.16 | W/°C |
| V_{GS} | Gate-to-Source Voltage | ±20 | V |
| I_{LM} | Inductive Current, Clamp | -7.0 | A |
| dv/dt | Peak Diode Recovery dv/dt ② | -5.0 | V/ns |
| T_J | Operating Junction and Storage Temperature Range | -55 to +150 | °C |
| T_{STG} | Soldering Temperature, for 10 seconds | 300 (1.6mm from case) | |
| | Mounting Torque, 6-32 or M3 screw | 10 lbf·in (1.1 N·m) | |

Thermal Resistance

| | Parameter | Min. | Typ. | Max. | Units |
|-----------------|-------------------------------------|------|------|------|-------|
| $R_{\theta JC}$ | Junction-to-Case | — | — | 6.4 | °C/W |
| $R_{\theta CS}$ | Case-to-Sink, Flat, Greased Surface | — | 0.50 | — | |
| $R_{\theta JA}$ | Junction-to-Ambient | — | — | 62 | |

Electrical Characteristics @ $T_J = 25^\circ\text{C}$ (unless otherwise specified)

| | Parameter | Min. | Typ. | Max. | Units | Test Conditions |
|---------------------------------|--------------------------------------|------|-------|------|--------------------|--|
| $V_{(BR)DSS}$ | Drain-to-Source Breakdown Voltage | -200 | — | — | V | $V_{GS}=0V, I_D=-250\mu A$ |
| $\Delta V_{(BR)DSS}/\Delta T_J$ | Breakdown Voltage Temp. Coefficient | — | -0.23 | — | $V/^\circ\text{C}$ | Reference to 25°C , $I_D=-1mA$ |
| $R_{DS(on)}$ | Static Drain-to-Source On-Resistance | — | — | 3.0 | Ω | $V_{GS}=10V, I_D=-0.90A$ ④ |
| $V_{GS(th)}$ | Gate Threshold Voltage | -2.0 | — | -4.0 | V | $V_{DS}=V_{GS}, I_D=-250\mu A$ |
| g_{fs} | Forward Transconductance | 0.90 | — | — | S | $V_{DS}=-50V, I_D=-0.90A$ ④ |
| I_{DSS} | Drain-to-Source Leakage Current | — | — | -100 | μA | $V_{DS}=-200V, V_{GS}=0V$ |
| | | — | — | -500 | | $V_{DS}=-160V, V_{GS}=0V, T_J=125^\circ\text{C}$ |
| I_{GSS} | Gate-to-Source Forward Leakage | — | — | -100 | nA | $V_{GS}=20V$ |
| | Gate-to-Source Reverse Leakage | — | — | 100 | | $V_{GS}=20V$ |
| Q_g | Total Gate Charge | — | — | 11 | nC | $I_D=-3.5A$ |
| Q_{gs} | Gate-to-Source Charge | — | — | 7.0 | | $V_{DS}=-160V$ |
| Q_{gd} | Gate-to-Drain ("Miller") Charge | — | — | 4.0 | | $V_{GS}=-10V$ See Fig. 11 & 18 ④ |
| $t_{d(on)}$ | Turn-On Delay Time | — | 8.0 | — | ns | $V_{DD}=-100V$ |
| t_r | Rise Time | — | 15 | — | | $I_D=-0.90A$ |
| $t_{d(off)}$ | Turn-Off Delay Time | — | 10 | — | | $R_G=50\Omega$ |
| t_f | Fall Time | — | 8.0 | — | | $R_D=110\Omega$ See Figure 17 ④ |
| L_D | Internal Drain Inductance | — | 4.5 | — | nH | Between lead, 6 mm (0.25in.) from package and center of die contact |
| L_S | Internal Source Inductance | — | 7.5 | — | |  |
| C_{iss} | Input Capacitance | — | 170 | — | pF | $V_{GS}=0V$ |
| C_{oss} | Output Capacitance | — | 50 | — | | $V_{DS}=-25V$ |
| C_{rss} | Reverse Transfer Capacitance | — | 15 | — | | $f=1.0MHz$ See Figure 10 |

Source-Drain Ratings and Characteristics

| | Parameter | Min. | Typ. | Max. | Units | Test Conditions |
|----------|--|---|------|------|---------|---|
| I_S | Continuous Source Current (Body Diode) | — | — | -1.8 | A | MOSFET symbol showing the integral reverse p-n junction diode.  |
| I_{SM} | Pulsed Source Current (Body Diode) ① | — | — | -7.0 | | |
| V_{SD} | Diode Forward Voltage | — | — | -5.8 | V | $T_J=25^\circ\text{C}, I_S=-1.8A, V_{GS}=0V$ ④ |
| t_{rr} | Reverse Recovery Time | — | 240 | 360 | ns | $T_J=25^\circ\text{C}, I_F=-1.8A$ |
| Q_{rr} | Reverse Recovery Charge | — | 1.7 | 2.6 | μC | $di/dt=100A/\mu s$ ④ |
| t_{on} | Forward Turn-On Time | Intrinsic turn-on time is negligible (turn-on is dominated by L_S+L_D) | | | | |

Notes:

- ① Repetitive rating; pulse width limited by max. junction temperature (See Figure 5)
- ② Not Applicable
- ③ $I_{SD} \leq 1.8A, di/dt \leq 70A/\mu s, V_{DD} \leq V_{(BR)DSS}, T_J \leq 150^\circ\text{C}$
- ④ Pulse width $\leq 300 \mu s$; duty cycle $\leq 2\%$.

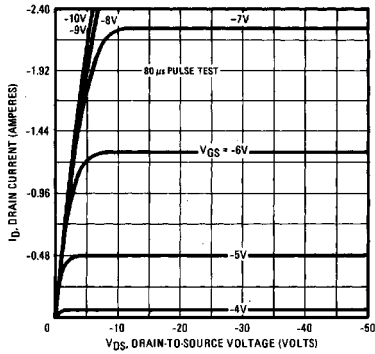

Fig. 1 — Typical Output Characteristics

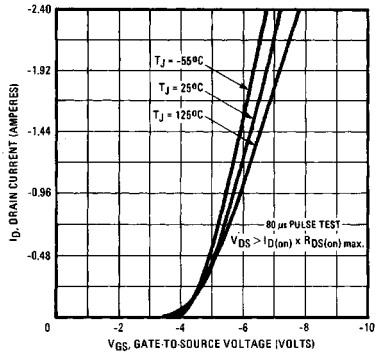

Fig. 2 — Typical Transfer Characteristics

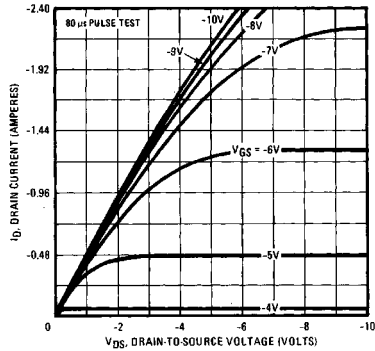

Fig. 3 — Typical Saturation Characteristics

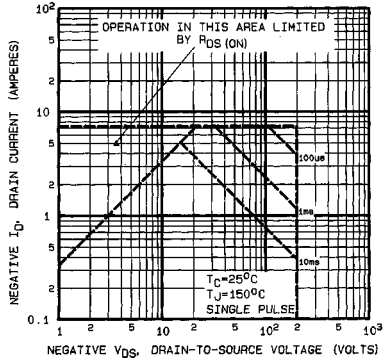

Fig. 4 — Maximum Safe Operating Area

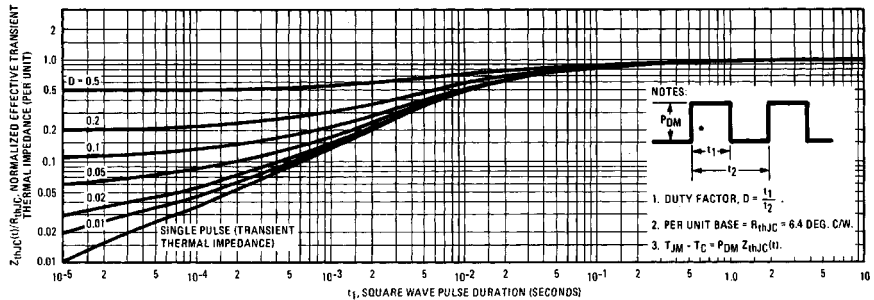

Fig. 5 — Maximum Effective Transient Thermal Impedance, Junction-to-Case Vs. Pulse Duration

DATA SHEETS

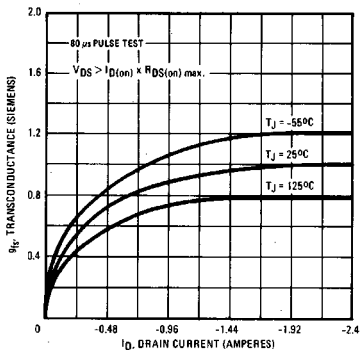

Fig. 6 — Typical Transconductance Vs. Drain Current

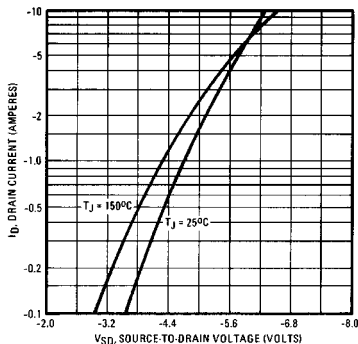

Fig. 7 — Typical Source-Drain Diode Forward Voltage

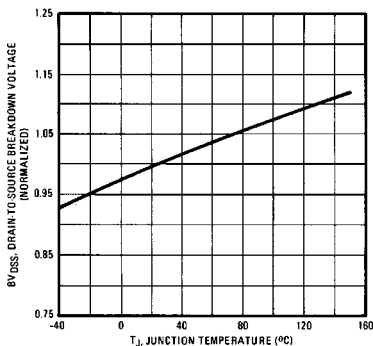

Fig. 8 — Breakdown Voltage Vs. Temperature

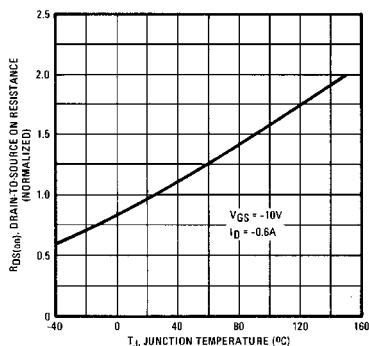

Fig. 9 — Normalized On-Resistance Vs. Temperature

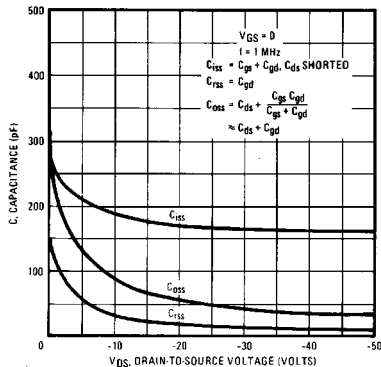

Fig. 10 — Typical Capacitance Vs. Drain-to-Source Voltage

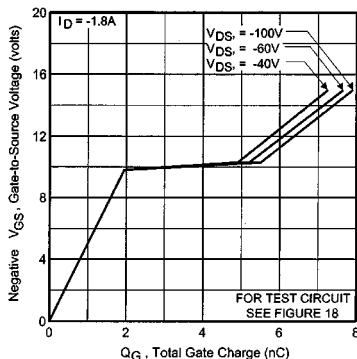

Fig. 11 — Typical Gate Charge Vs. Gate-to-Source Voltage

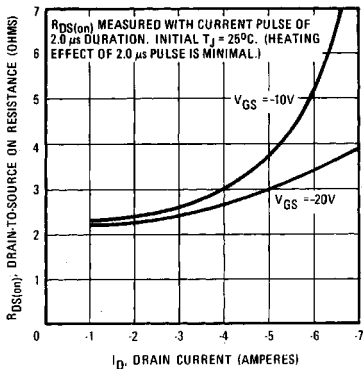

Fig. 12 — Typical On-Resistance Vs. Drain Current

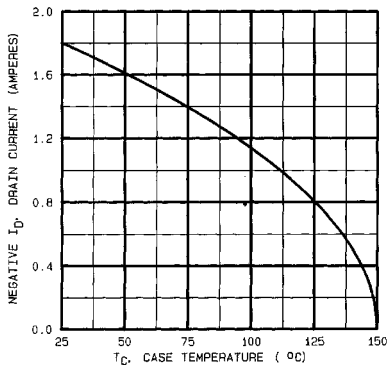

Fig. 13 — Maximum Drain Current Vs. Case Temperature

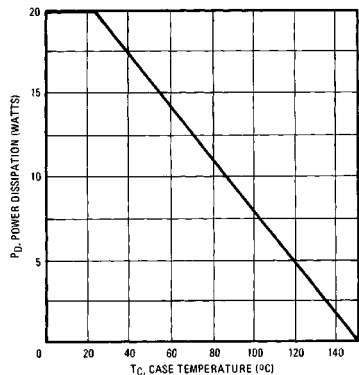

Fig. 14 — Power Vs. Temperature Derating Curve

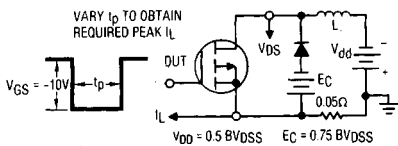

Fig. 15 — Clamped Inductive Test Circuit

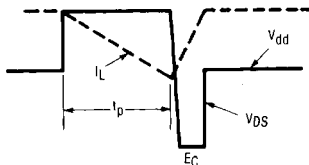

Fig. 16 — Clamped Inductive Waveforms

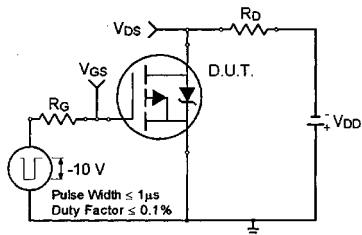

Fig. 17a — Switching Time Test Circuit

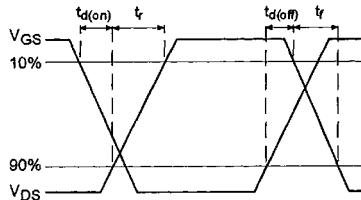

Fig. 17b — Switching Time Waveforms

DATA SHEETS

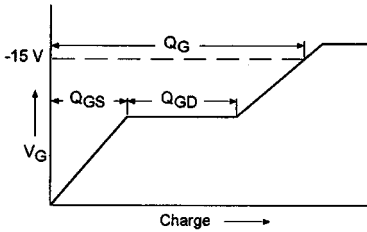

Fig. 18a — Basic Gate Charge Waveform

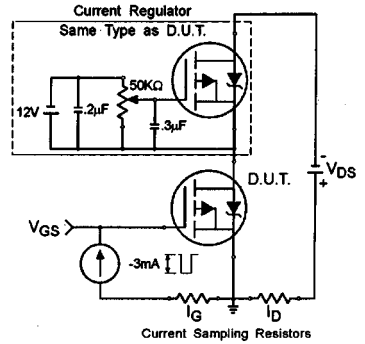

Fig. 18b — Gate Charge Test Circuit

Appendix A: Figure 14, Peak Diode Recovery dv/dt Test Circuit – See page 1506

Appendix B: Package Outline Mechanical Drawing – See page 1509

Appendix C: Part Marking Information – See page 1516

Appendix E: Optional Leadforms – See page 1525

**International
IR Rectifier**

This datasheet has been download from:

www.datasheetcatalog.com

Datasheets for electronics components.