

# Amplifier Transistors

## NPN Silicon

**BC546, B**  
**BC547, A, B, C**  
**BC548, A, B, C**

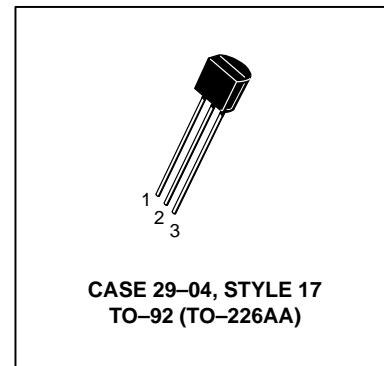

### MAXIMUM RATINGS

Rating	Symbol	BC 546	BC 547	BC 548	Unit
Collector–Emitter Voltage	$V_{CEO}$	65	45	30	Vdc
Collector–Base Voltage	$V_{CBO}$	80	50	30	Vdc
Emitter–Base Voltage	$V_{EBO}$	6.0			Vdc
Collector Current — Continuous	$I_C$	100			mAdc
Total Device Dissipation @ $T_A = 25^\circ\text{C}$ Derate above $25^\circ\text{C}$	$P_D$	625			mW
		5.0			mW/°C
Total Device Dissipation @ $T_C = 25^\circ\text{C}$ Derate above $25^\circ\text{C}$	$P_D$	1.5			Watt
		12			mW/°C
Operating and Storage Junction Temperature Range	$T_J, T_{stg}$	–55 to +150			°C

### THERMAL CHARACTERISTICS

Characteristic	Symbol	Max	Unit
Thermal Resistance, Junction to Ambient	$R_{\theta JA}$	200	°C/W
Thermal Resistance, Junction to Case	$R_{\theta JC}$	83.3	°C/W

### ELECTRICAL CHARACTERISTICS ( $T_A = 25^\circ\text{C}$ unless otherwise noted)

Characteristic	Symbol	Min	Typ	Max	Unit
----------------	--------	-----	-----	-----	------

### OFF CHARACTERISTICS

Collector–Emitter Breakdown Voltage ( $I_C = 1.0\text{ mA}, I_B = 0$ )	BC546 BC547 BC548	$V_{(BR)CEO}$	65 45 30	— — —	— — —	V
Collector–Base Breakdown Voltage ( $I_C = 100\ \mu\text{Adc}$ )	BC546 BC547 BC548	$V_{(BR)CBO}$	80 50 30	— — —	— — —	V
Emitter–Base Breakdown Voltage ( $I_E = 10\ \mu\text{A}, I_C = 0$ )	BC546 BC547 BC548	$V_{(BR)EBO}$	6.0 6.0 6.0	— — —	— — —	V
Collector Cutoff Current ( $V_{CE} = 70\text{ V}, V_{BE} = 0$ ) ( $V_{CE} = 50\text{ V}, V_{BE} = 0$ ) ( $V_{CE} = 35\text{ V}, V_{BE} = 0$ ) ( $V_{CE} = 30\text{ V}, T_A = 125^\circ\text{C}$ )	BC546 BC547 BC548 BC546/547/548	$I_{CES}$	— — — —	0.2 0.2 0.2 —	15 15 15 4.0	nA   $\mu\text{A}$

**BC546, B BC547, A, B, C BC548, A, B, C**
**ELECTRICAL CHARACTERISTICS** ( $T_A = 25^\circ\text{C}$  unless otherwise noted) (Continued)

Characteristic	Symbol	Min	Typ	Max	Unit
<b>ON CHARACTERISTICS</b>					
DC Current Gain ( $I_C = 10\ \mu\text{A}$ , $V_{CE} = 5.0\ \text{V}$ )	BC547A/548A BC546B/547B/548B BC548C	— — —	90 150 270	— — —	—
( $I_C = 2.0\ \text{mA}$ , $V_{CE} = 5.0\ \text{V}$ )	BC546 BC547 BC548 BC547A/548A BC546B/547B/548B BC547C/BC548C	110 110 110 110 200 420	— — — 180 290 520	450 800 800 220 450 800	
( $I_C = 100\ \text{mA}$ , $V_{CE} = 5.0\ \text{V}$ )	BC547A/548A BC546B/547B/548B BC548C	— — —	120 180 300	— — —	
Collector–Emitter Saturation Voltage ( $I_C = 10\ \text{mA}$ , $I_B = 0.5\ \text{mA}$ ) ( $I_C = 100\ \text{mA}$ , $I_B = 5.0\ \text{mA}$ ) ( $I_C = 10\ \text{mA}$ , $I_B = \text{See Note 1}$ )	$V_{CE(\text{sat})}$	— — —	0.09 0.2 0.3	0.25 0.6 0.6	V
Base–Emitter Saturation Voltage ( $I_C = 10\ \text{mA}$ , $I_B = 0.5\ \text{mA}$ )	$V_{BE(\text{sat})}$	—	0.7	—	V
Base–Emitter On Voltage ( $I_C = 2.0\ \text{mA}$ , $V_{CE} = 5.0\ \text{V}$ ) ( $I_C = 10\ \text{mA}$ , $V_{CE} = 5.0\ \text{V}$ )	$V_{BE(\text{on})}$	0.55 —	— —	0.7 0.77	V

**SMALL–SIGNAL CHARACTERISTICS**

Current–Gain — Bandwidth Product ( $I_C = 10\ \text{mA}$ , $V_{CE} = 5.0\ \text{V}$ , $f = 100\ \text{MHz}$ )	BC546 BC547 BC548	$f_T$	150 150 150	300 300 300	— — —	MHz
Output Capacitance ( $V_{CB} = 10\ \text{V}$ , $I_C = 0$ , $f = 1.0\ \text{MHz}$ )		$C_{obo}$	—	1.7	4.5	pF
Input Capacitance ( $V_{EB} = 0.5\ \text{V}$ , $I_C = 0$ , $f = 1.0\ \text{MHz}$ )		$C_{ibo}$	—	10	—	pF
Small–Signal Current Gain ( $I_C = 2.0\ \text{mA}$ , $V_{CE} = 5.0\ \text{V}$ , $f = 1.0\ \text{kHz}$ )	BC546 BC547/548 BC547A/548A BC546B/547B/548B BC547C/548C	$h_{fe}$	125 125 125 240 450	— — 220 330 600	500 900 260 500 900	—
Noise Figure ( $I_C = 0.2\ \text{mA}$ , $V_{CE} = 5.0\ \text{V}$ , $R_S = 2\ \text{k}\Omega$ , $f = 1.0\ \text{kHz}$ , $\Delta f = 200\ \text{Hz}$ )	BC546 BC547 BC548	NF	— — —	2.0 2.0 2.0	10 10 10	dB

Note 1:  $I_B$  is value for which  $I_C = 11\ \text{mA}$  at  $V_{CE} = 1.0\ \text{V}$ .

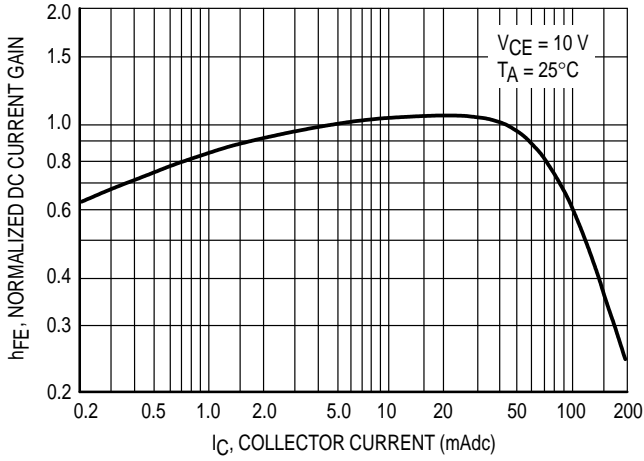

Figure 1. Normalized DC Current Gain

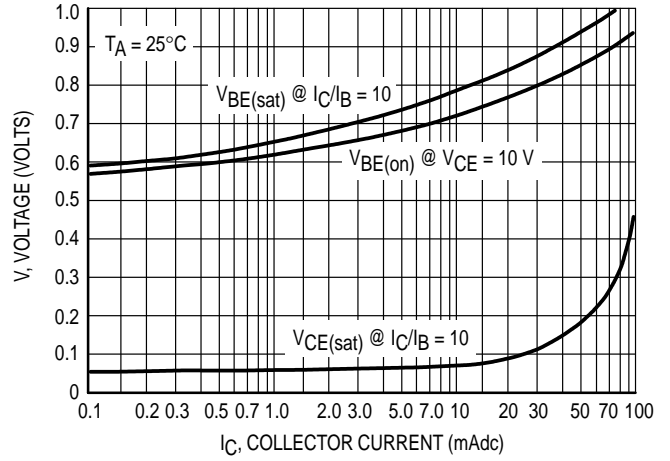

Figure 2. "Saturation" and "On" Voltages

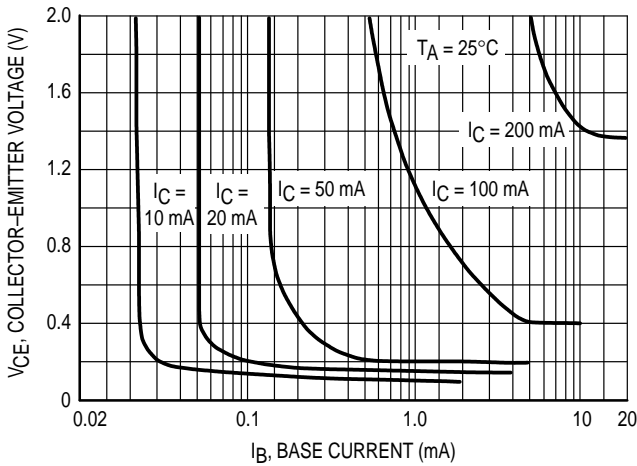

Figure 3. Collector Saturation Region

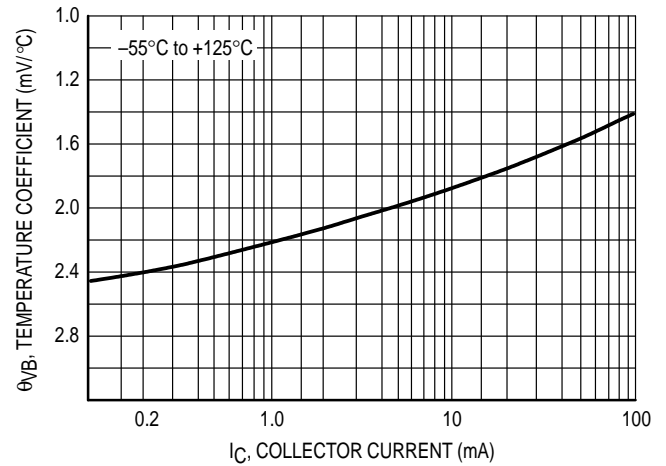

Figure 4. Base-Emitter Temperature Coefficient

BC547/BC548

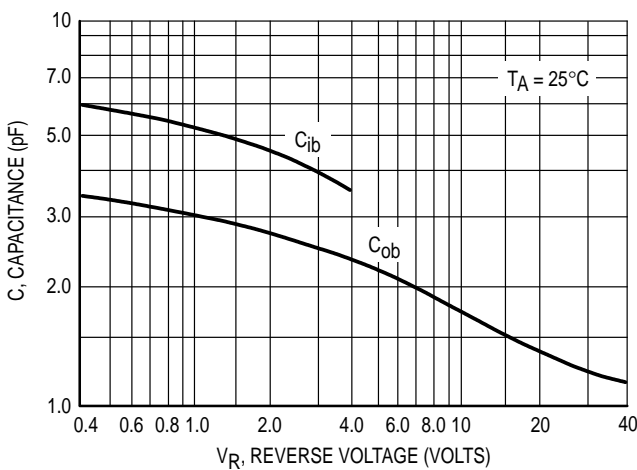

Figure 5. Capacitances

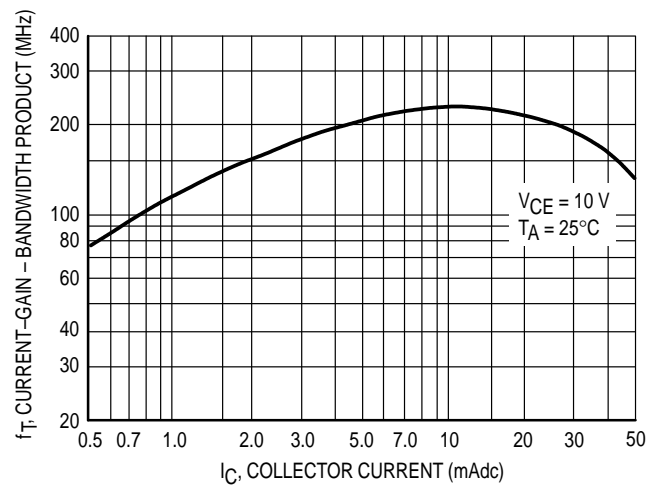

Figure 6. Current-Gain - Bandwidth Product

BC547/BC548

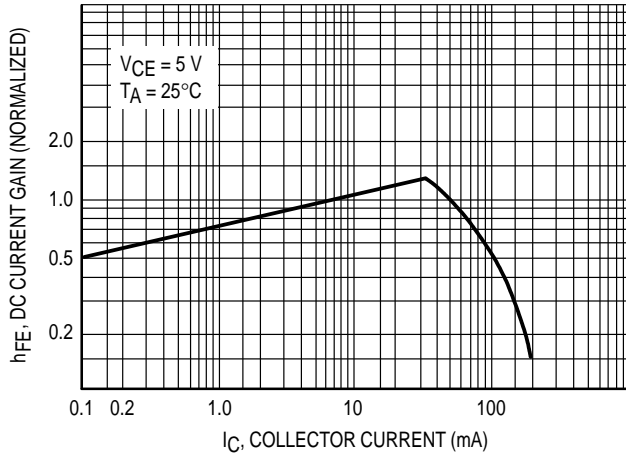

Figure 7. DC Current Gain

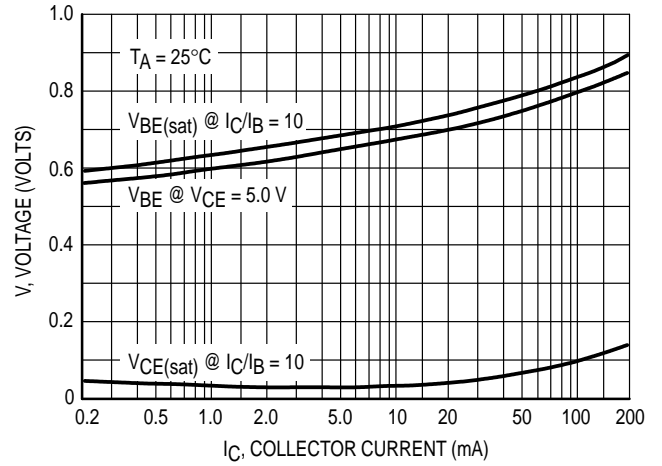

Figure 8. "On" Voltage

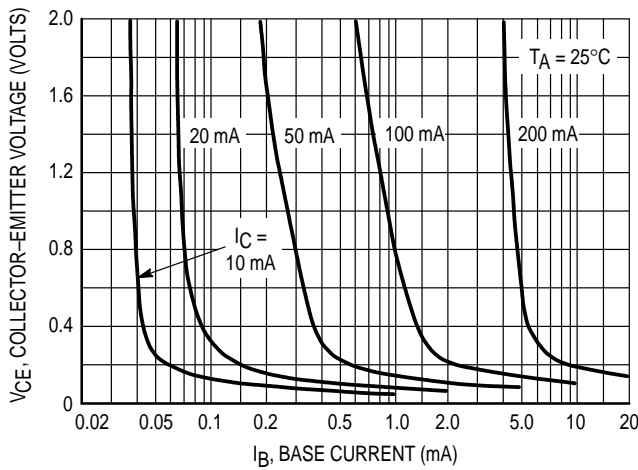

Figure 9. Collector Saturation Region

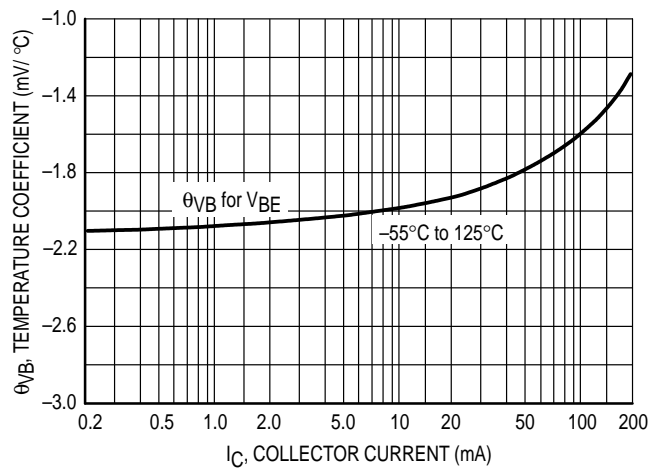

Figure 10. Base-Emitter Temperature Coefficient

BC546

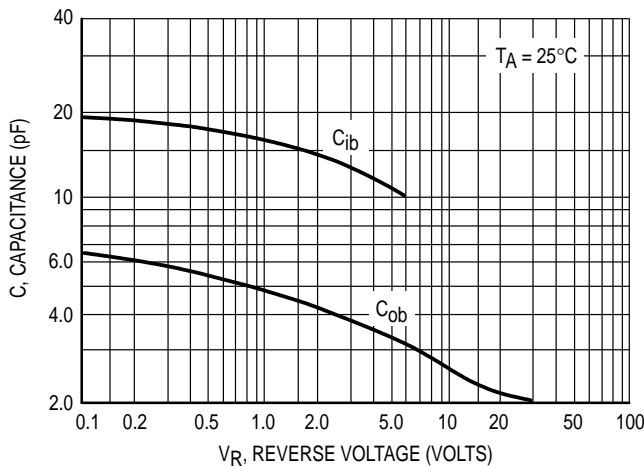

Figure 11. Capacitance

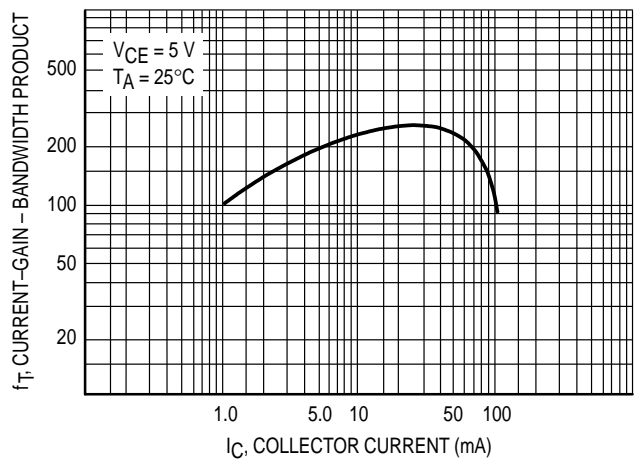
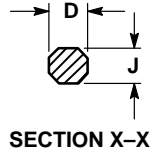
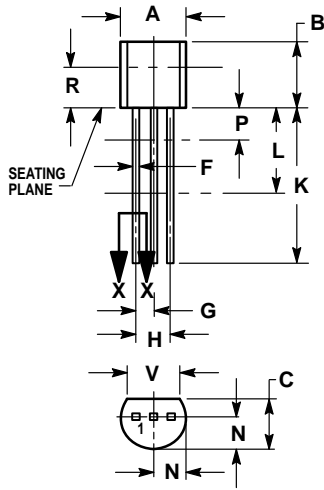

Figure 12. Current-Gain - Bandwidth Product

PACKAGE DIMENSIONS



NOTES:

1. DIMENSIONING AND TOLERANCING PER ANSI Y14.5M, 1982.
2. CONTROLLING DIMENSION: INCH.
3. CONTOUR OF PACKAGE BEYOND DIMENSION R IS UNCONTROLLED.
4. DIMENSION F APPLIES BETWEEN P AND L. DIMENSION D AND J APPLY BETWEEN L AND K. MINIMUM LEAD DIMENSION IS UNCONTROLLED IN P AND BEYOND DIMENSION K MINIMUM.

DIM	INCHES		MILLIMETERS	
	MIN	MAX	MIN	MAX
A	0.175	0.205	4.45	5.20
B	0.170	0.210	4.32	5.33
C	0.125	0.165	3.18	4.19
D	0.016	0.022	0.41	0.55
F	0.016	0.019	0.41	0.48
G	0.045	0.055	1.15	1.39
H	0.095	0.105	2.42	2.66
J	0.015	0.020	0.39	0.50
K	0.500	—	12.70	—
L	0.250	—	6.35	—
N	0.080	0.105	2.04	2.66
P	—	0.100	—	2.54
R	0.115	—	2.93	—
V	0.135	—	3.43	—

CASE 029-04  
(TO-226AA)  
ISSUE AD

STYLE 17:

- PIN 1. COLLECTOR
2. BASE
3. EMITTER

Motorola reserves the right to make changes without further notice to any products herein. Motorola makes no warranty, representation or guarantee regarding the suitability of its products for any particular purpose, nor does Motorola assume any liability arising out of the application or use of any product or circuit, and specifically disclaims any and all liability, including without limitation consequential or incidental damages. "Typical" parameters can and do vary in different applications. All operating parameters, including "Typicals" must be validated for each customer application by customer's technical experts. Motorola does not convey any license under its patent rights nor the rights of others. Motorola products are not designed, intended, or authorized for use as components in systems intended for surgical implant into the body, or other applications intended to support or sustain life, or for any other application in which the failure of the Motorola product could create a situation where personal injury or death may occur. Should Buyer purchase or use Motorola products for any such unintended or unauthorized application, Buyer shall indemnify and hold Motorola and its officers, employees, subsidiaries, affiliates, and distributors harmless against all claims, costs, damages, and expenses, and reasonable attorney fees arising out of, directly or indirectly, any claim of personal injury or death associated with such unintended or unauthorized use, even if such claim alleges that Motorola was negligent regarding the design or manufacture of the part. Motorola and  are registered trademarks of Motorola, Inc. Motorola, Inc. is an Equal Opportunity/Affirmative Action Employer.

**How to reach us:**

**USA/EUROPE:** Motorola Literature Distribution;  
P.O. Box 20912; Phoenix, Arizona 85036. 1-800-441-2447

**JAPAN:** Nippon Motorola Ltd.; Tatsumi-SPD-JLDC, Toshikatsu Otsuki,  
6F Seibu-Butsuryu-Center, 3-14-2 Tatsumi Koto-Ku, Tokyo 135, Japan. 03-3521-8315

**MFAX:** RMFAX0@email.sps.mot.com – TOUCHTONE (602) 244-6609  
**INTERNET:** <http://Design-NET.com>

**HONG KONG:** Motorola Semiconductors H.K. Ltd.; 8B Tai Ping Industrial Park,  
51 Ting Kok Road, Tai Po, N.T., Hong Kong. 852-26629298

