

power light source

LUXEON[®] Star

Introduction

LUXEON[®] is a revolutionary, energy efficient and ultra compact new light source, combining the lifetime and reliability advantages of Light Emitting Diodes with the brightness of conventional lighting.

LUXEON features one or more power light sources mounted onto an aluminum-core printed circuit board, allowing for ease of assembly, optimum cooling and accurate light center positioning.

For tight beams, optional and highly efficient collimating optics are available.

LUXEON Power Light Sources give you total design freedom and unmatched brightness, creating a new world of light.

For high volume applications, custom LUXEON power light source designs are available upon request, to meet your specific needs.

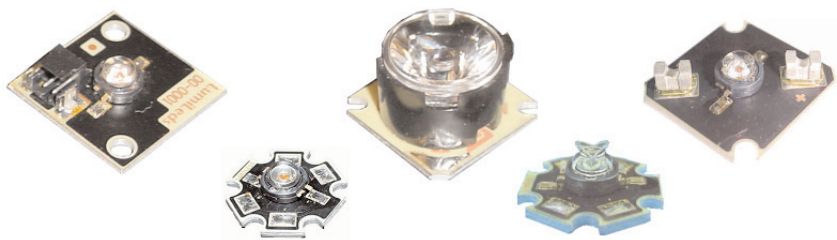

LUXEON Star is available in white, warm white, green, blue, royal blue, cyan, red, red-orange and amber.



Features

- ◆ Highest flux per LED family in the world
- ◆ Very long operating life (up to 100k hours)
- ◆ Available in White, Green, Blue, Royal Blue, Cyan, Red, Red-Orange and Amber
- ◆ Lambertian, Batwing, Side Emitting or Collimated radiation patterns
- ◆ More energy efficient than incandescent and most halogen lamps
- ◆ Low voltage DC operated
- ◆ Cool beam, safe to the touch
- ◆ Instant light (less than 100 ns)
- ◆ Fully dimmable
- ◆ No UV
- ◆ Superior ESD protection

Typical Applications

- ◆ Reading lights (car, bus, aircraft)
- ◆ Portable (flashlight, bicycle)
- ◆ Orientation
- ◆ Mini-accent
- ◆ Decorative
- ◆ Fiber optic alternative
- ◆ Appliance
- ◆ Sign and channel letter
- ◆ Architectural detail
- ◆ Cove lighting
- ◆ Automotive exterior (Stop-Tail-Turn, CHMSL, Mirror side repeat)
- ◆ Edge-lit signs (Exit, point of sale)

Mechanical Dimensions

LUXEON Star



Side Emitting

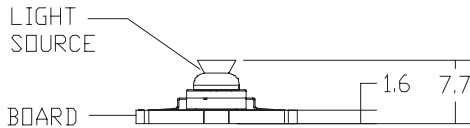

Batwing

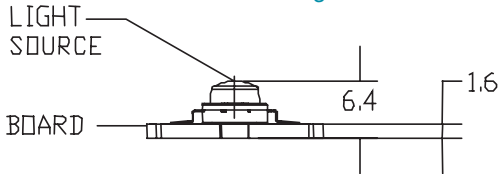

Lambertian

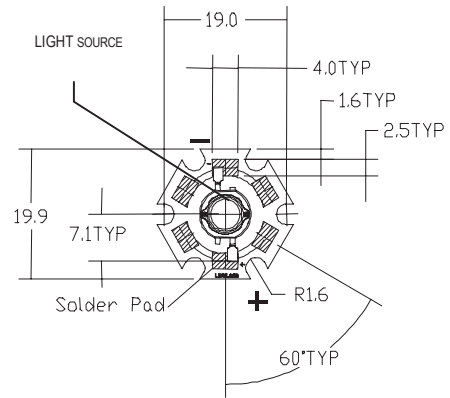
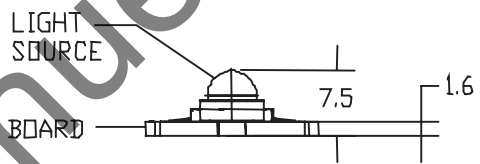

Notes:

1. Slots in aluminum-core PCB for M3 or #4 mounting screw.
2. Electrical interconnection pads labeled on the aluminum-core PCB with "+" and "-" to denote positive and negative, respectively. All positive pads are interconnected, as are all negative pads, allowing for flexibility in array interconnection.
3. Drawings not to scale.
4. All dimensions are in millimeters.

LUXEON Star Warm White

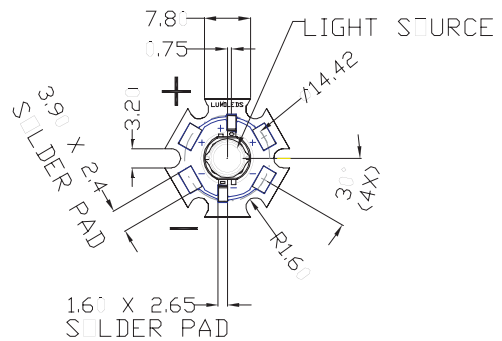
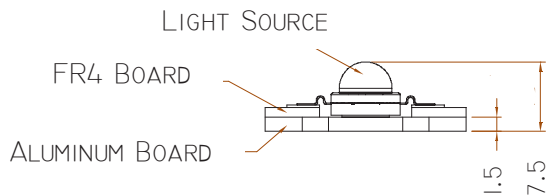

Notes:

1. Slots in aluminum-core PCB for M3 or #4 mounting screw.
2. Electrical interconnection pads labeled on the aluminum-core PCB with "+" and "-" to denote positive and negative, respectively. All positive pads are interconnected, as are all negative pads, allowing for flexibility in array interconnection.
3. Electrical insulation between neighboring Stars is required - aluminum board is not electrically neutral.
4. Drawings not to scale.
5. All dimensions are in millimeters.

LUXEON Star/C

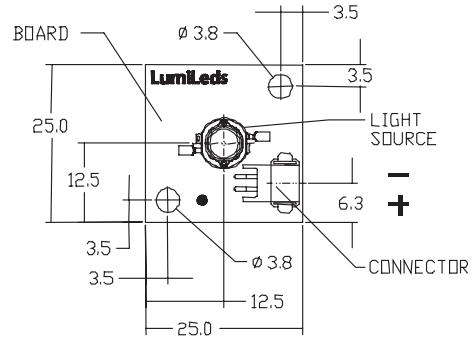
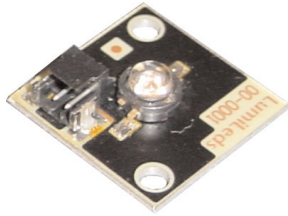

Batwing

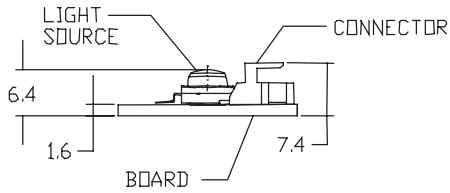

Lambertian

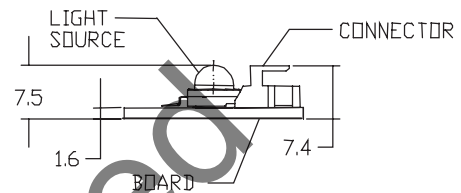

Notes:

1. Holes in aluminum-core PCB for M3 or #4 mounting screw.
2. Connector on board AMP type, code 2-179123-2 ; Mating connector—AMP receptacle housing assembly, code 173977-2.
3. Positive and negative pins in connector are as indicated on the drawing.
4. Drawings not to scale.
5. All dimensions are in millimeters.

LUXEON Star/IDC

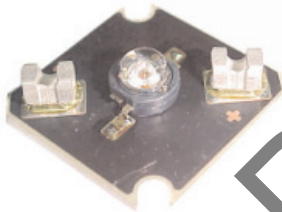

Batwing

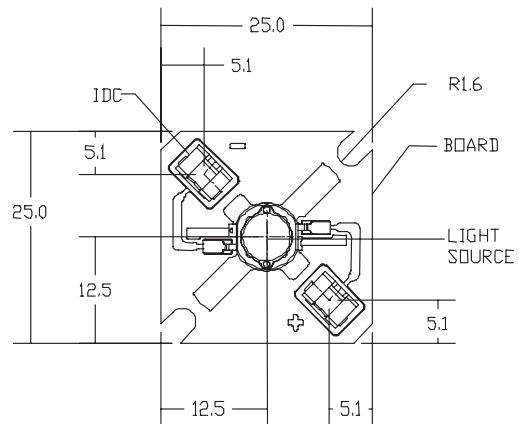
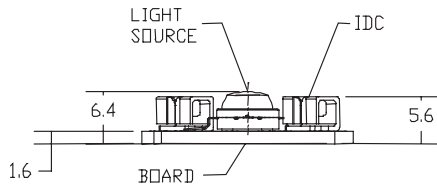

Notes:

1. Slots in aluminum-core PCB for M3 or #4 mounting screw.
2. Connectors on board Zierick type, code 1245T; accepts #26-18 AWG wire. Compatible with Zierick manual wire insertion tool WTP-4ALL and pneumatic production tool WTPPS-1208-1.
3. Positive and negative IDC connectors are indicated with a "+" and a "-" on the aluminum-core PCB, respectively.
4. Drawings not to scale.
5. All dimensions are in millimeters.

LUXEON Star/O

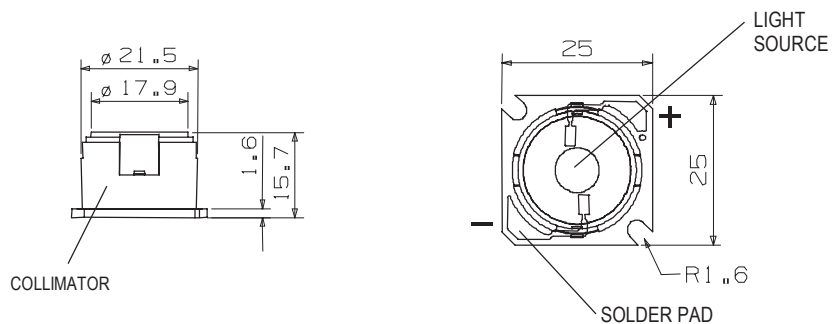

Notes:

1. Slots in aluminum-core PCB for M3 or #4 mounting screw.
2. Positive solder pad is indicated by a copper dot next to the pad on the aluminum-core PCB.
3. The collimator is molded from optical grade acrylic. Do not subject to temperatures greater than 75°C, as plastic deformation may occur. Protect optic against exposure to solvents and adhesives that are not compatible with acrylic.
4. Drawings not to scale.
5. All dimensions are in millimeters.

Part Number Matrix

Table 1.

Color	Star	Star/C	Star/O ^[1]	Star/IDC ^[2]	Beam Pattern	
White ^[3]	LXHL-MWEC	LXHL-MWEA	LXHL-NWE8	N/A	Batwing	
Warm White	LXHL-MWGC	N/A	LXHL-NWG8	N/A		
Green	LXHL-MM1C	LXHL-MM1A	LXHL-NM98	LXHL-MM1E		
Cyan	LXHL-ME1C	LXHL-ME1A	LXHL-NE98	LXHL-ME1E		
Blue	LXHL-MB1C	LXHL-MB1A	LXHL-NB98	LXHL-MB1E		
Royal Blue	LXHL-MRRC	LXHL-MRRA	LXHL-NRR8	LXHL-MR1E		
Red	LXHL-MD1C	LXHL-MD1A	LXHL-ND98	LXHL-MD1E		
Red	LXHL-MDAC	N/A	N/A	N/A		
Red-Orange	LXHL-MHAC	N/A	N/A	N/A		
Amber	LXHL-ML1C	LXHL-ML1A	LXHL-NL98	LXHL-ML1E		
Amber	LXHL-MLAC	N/A	N/A	N/A		
White	LXHL-MW1D	LXHL-MW1B	N/A	N/A		Lambertian
Green	LXHL-MM1D	LXHL-MM1B	N/A	N/A		
Cyan	LXHL-ME1D	LXHL-ME1B	N/A	N/A		
Blue	LXHL-MB1D	LXHL-MB1B	N/A	N/A		
Royal Blue	LXHL-MRRD	LXHL-MRRB	N/A	N/A		
Red	LXHL-MD1D	LXHL-MD1B	LXHL-ND94	N/A		
Red-Orange	LXHL-MH1D	LXHL-MH1B	LXHL-NH94	N/A		
Amber	LXHL-ML1D	LXHL-ML1B	LXHL-NL94	N/A		
White	LXHL-FW1C	N/A	N/A	N/A	Side Emitting	
Green	LXHL-FM1C	N/A	N/A	N/A		
Cyan	LXHL-FE1C	N/A	N/A	N/A		
Blue	LXHL-FB1C	N/A	N/A	N/A		
Royal Blue	LXHL-FR1C	N/A	N/A	N/A		
Red	LXHL-FD1C	N/A	N/A	N/A		
Red-Orange	LXHL-FH1C	N/A	N/A	N/A		
Amber	LXHL-FL1C	N/A	N/A	N/A		

Notes for Table 1:

1. Star/O produces a narrow collimated beam due to the inclusion of the collimating optic. In red, red-orange, and amber the Star/O listed under lambertian radiation pattern is higher in luminous output, although the collimated beam pattern is similar to the Star/O products based on the batwing emitter.
2. Star/IDC available in the batwing radiation pattern only. The wide angle of optical output from a lambertian or side emitting device results in significant light loss due to the IDC connectors in the optical path. In July 2003 Lumileds announced a second-generation line of white batwing products using a new phosphor deposition process resulting in improved color uniformity. These new batwing emitters (LXHL-BW02) are incorporated into LUXEON Star part numbers LXHL-MWEC, LXHL-MWEA LXHL-NWE8, LXHL-MW1D, LXHL-MW1B and LXHL-FW1C.

Flux Characteristics at 350mA, Junction Temperature, $T_J = 25^\circ\text{C}$

Table 2.

Color	Minimum Luminous Flux (lm) or Radiometric Power (mW) Φ_V [1,2]	Typical Luminous Flux (lm) or Radiometric Power (mW) Φ_V [2]	Radiation Pattern
White	30.6	45	Batwing
Warm White	13.9	20	
Green	30.6	53	
Cyan	30.6	45	
Blue ^[3]	8.2	16	
Royal Blue ^[4]	145 mW	220 mW	
Red (MD1C)	13.9	27	
Red (MDAC)	30.6	42	
Red-Orange	39.8	55	
Amber (ML1C)	10.7	25	
Amber (MLAC)	23.5	42	
White	30.6	45	Lambertian
Green	30.6	53	
Cyan	30.6	45	
Blue ^[3]	8.2	16	
Royal Blue ^[4]	145 mW	220 mW	
Red	30.6	44	
Red-Orange	39.8	55	
Amber	23.5	42	
White	23.5	40.5	Side Emitting
Green	23.5	48	
Cyan	23.5	40.5	
Blue ^[3]	8.2	14.5	
Royal Blue ^[4]	115 mW	198 mW	
Red	30.6	40	
Red-Orange	39.8	50	
Amber	23.5	38	

Notes for Table 2:

1. Minimum luminous flux or radiometric power performance guaranteed within published operating conditions. Lumileds maintains a tolerance of $\pm 10\%$ on flux and power measurements.
2. Flux and power values for LUXEON Star without secondary optics. The efficiency of collimating optics is approximately 85%. LUXEON types with even higher luminous flux levels will become available in the future. Please consult your Lumileds Authorized Distributor or Lumileds sales representative for more information.
3. Minimum flux value for 470 nm devices. Due to the CIE eye response curve in the short blue wavelength range, the minimum luminous flux will vary over the Lumileds' blue color range. Luminous flux will vary from a minimum of 6.3 lm at 460 nm to a typical of 20 lm at 480 nm due to this effect. Although the luminous power efficiency is lower in the short blue wavelength range, radiometric power efficiency increases as wavelength decreases. For more information, consult the LUXEON Design Guide, available upon request.
4. Royal Blue product is binned by radiometric power and peak wavelength rather than photometric lumens and dominant wavelength.

Optical Characteristics at 350mA, Junction Temperature, $T_J = 25^\circ\text{C}$

Table 3.

Color	Dominant Wavelength ^[1] λ_D , Peak Wavelength ^[2] λ_P , or Color Temperature ^[3]			Spectral Half-width ^[4] (nm) $\Delta\lambda_{1/2}$	Temperature Coefficient of Dominant Wavelength (nm/ $^\circ\text{C}$) $\Delta\lambda_D / \Delta T_J$
	Min.	CCT Typ.	Max.		
White	4500 K	5500 K	10000 K	-----	-----
Warm White	2850K	3300K	3800K	-----	-----
Green	520 nm	530 nm	550 nm	35	0.04
Cyan	490 nm	505 nm	520 nm	30	0.04
Blue	460 nm	470 nm	490 nm	25	0.04
Royal Blue ^[2]	440 nm	455 nm	460 nm	20	0.04
Red	620.5 nm	625 nm	645.0 nm	20	0.05
Red-Orange	612.5 nm	617 nm	620.5 nm	20	0.06
Amber	587.5 nm	590 nm	597.0 nm	14	0.09

Optical Characteristics at 350mA, Junction Temperature, $T_J = 25^\circ\text{C}$ Continued

Table 4.

Radiation Pattern	Color	LUXEON Star & LUXEON Star/C		LUXEON Star/O (with optics)		
		Total Included Angle ^[5] (degree) $\theta_{0.90V}$	Viewing Angle ^[6] (degree) $2\theta_{1/2}$	Total Included Angle ^[5] (degree) $\theta_{0.90V}$	Viewing Angle ^[6] (degree) $2\theta_{1/2}$	Typical Candela on Axis ^[7] (cd)
Batwing	White (All Except NWE8)	110	110	25	10	250
	White (NWE8)	110	110	25	10	500
	Warm White	110	110	25	10	200
	Green	110	110	25	10	600
	Cyan	110	110	25	10	600
	Blue	110	110	25	10	200 ^[7]
	Royal Blue	110	110	25	10	120
	Red (MD1C)	110	110	25	10	810
	Red (MDAC)	110	110	N/A	N/A	N/A
	Red-Orange	110	110	N/A	N/A	N/A
	Amber (ML1C)	110	110	25	10	750
	Amber (MLAC)	110	110	N/A	N/A	N/A
	Lambertian	White	160	140	N/A	N/A
Green		160	140	N/A	N/A	N/A
Cyan		160	140	N/A	N/A	N/A
Blue		160	140	N/A	N/A	N/A
Royal Blue		160	140	N/A	N/A	N/A
Red		160	140	25	10	660
Red-Orange		160	140	25	10	825
Amber		160	140	25	10	640

Optical Characteristics at 350mA, Junction Temperature, $T_J = 25^\circ\text{C}$ Continued

Table 5.

Radiation Pattern	Color	Typical Total Flux Percent within first 45° ^[8]	Typical Angle of Peak Intensity ^[9]
		Cum Φ_{45°	θ_{Peak}
Side Emitting	White	<15%	$75^\circ - 85^\circ$
	Green	<15%	$75^\circ - 85^\circ$
	Cyan	<15%	$75^\circ - 85^\circ$
	Blue	<15%	$75^\circ - 85^\circ$
	Royal blue	<15%	$75^\circ - 85^\circ$
	Red	<15%	$75^\circ - 85^\circ$
	Red-Orange	<15%	$75^\circ - 85^\circ$
	Amber	<15%	$75^\circ - 85^\circ$

Notes for Tables 3, 4 and 5:

1. Dominant wavelength is derived from the CIE 1931 Chromaticity diagram and represents the perceived color. Lumileds maintains a tolerance of $\pm 0.5\text{nm}$ for dominant wavelength measurements.
2. Royal Blue product is binned by radiometric power and peak wavelength rather than photometric lumens and dominant wavelength. Lumileds maintains a tolerance of $\pm 2\text{nm}$ for peak wavelength measurements.
3. CCT $\pm 5\%$ tester tolerance.
4. Spectral width at $\frac{1}{2}$ of the peak intensity.
5. Total angle at which 90% of total luminous flux is captured.
6. $\theta_{\frac{1}{2}}$ is the off axis angle from lamp centerline where the luminous intensity is $\frac{1}{2}$ of the peak value.
7. Typical candela on axis for 470 nm devices. Due to the CIE eye response curve in the short blue wavelength range, candela values will vary over Lumileds' blue color range.
8. Cumulative flux percent within $\pm 45^\circ$ from optical axis.
9. CRI (Color Rendering Index) for white product types is 70. CRI for warm white product types is 90 with typical R_9 value of 70.
10. Off axis angle from lamp centerline where the luminous intensity reaches the peak value.
11. All red, red-orange and amber products built with Aluminum Indium Gallium Phosphide (AlInGaP).
12. All white, green, cyan, blue and royal blue products built with Indium Gallium Nitride (InGaN).
13. Blue and Royal Blue power light sources represented here are IEC825 Class 2 for eye safety.

Electrical Characteristics at 350mA, Junction Temperature, $T_J = 25^\circ\text{C}$

Table 6.

Radiation Pattern	Color	Forward Voltage V_F ^[1]			Dynamic Resistance ^[2] (Ω) R_D	Temperature Coefficient of Forward Voltage ^[3] (mV/ $^\circ\text{C}$) $\Delta V_F / \Delta T_J$	Thermal Resistance, Junction to Board ($^\circ\text{C}/\text{W}$) $R_{\theta_{J-B}}$
		Min.	Typ.	Max.			
Batwing	White	2.79	3.42	3.99	1.0	-2.0	20
	Warm White	2.79	3.42	3.99	1.0	-2.0	20
	Green	2.79	3.42	3.99	1.0	-2.0	20
	Cyan	2.79	3.42	3.99	1.0	-2.0	20
	Blue	2.79	3.42	3.99	1.0	-2.0	20
	Royal Blue	2.79	3.42	3.99	1.0	-2.0	20
	Red (MD1C)	2.31	2.85	3.27	2.4	-2.0	20
	Red (MDAC)	2.31	2.95	3.51	2.4	-2.0	23
	Red-Orange	2.31	2.95	3.51	2.4	-2.0	23
	Amber (ML1C)	2.31	2.85	3.27	2.4	-2.0	20
Amber (MLAC)	2.31	2.95	3.51	2.4	-2.0	23	
Lambertian	White	2.79	3.42	3.99	1.0	-2.0	20
	Green	2.79	3.42	3.99	1.0	-2.0	20
	Cyan	2.79	3.42	3.99	1.0	-2.0	20
	Blue	2.79	3.42	3.99	1.0	-2.0	20
	Royal Blue	2.79	3.42	3.99	1.0	-2.0	20
	Red	2.31	2.95	3.51	2.4	-2.0	23
	Red-Orange	2.31	2.95	3.51	2.4	-2.0	23
	Amber	2.31	2.95	3.51	2.4	-2.0	23
Side Emitting	White	2.79	3.42	3.99	1.0	-2.0	20
	Green	2.79	3.42	3.99	1.0	-2.0	20
	Cyan	2.79	3.42	3.99	1.0	-2.0	20
	Blue	2.79	3.42	3.99	1.0	-2.0	20
	Royal Blue	2.79	3.42	3.99	1.0	-2.0	20
	Red	2.31	2.95	3.51	2.4	-2.0	23
	Red-Orange	2.31	2.95	3.51	2.4	-2.0	23
	Amber	2.31	2.95	3.51	2.4	-2.0	23

Notes for Table 6:

1. Lumileds maintains a tolerance of $\pm 0.06\text{V}$ on forward voltage measurements.
2. Dynamic resistance is the inverse of the slope in linear forward voltage model for LEDs. See Figures 3a and 3b. Measured between $25^\circ\text{C} \leq T_J \leq 110^\circ\text{C}$ at $I_F = 350\text{mA}$.

Absolute Maximum Ratings

Table 7.

Parameter	White/Green/ Cyan/Blue/ Royal Blue	Warm White	Red/ Red-Orange/ Amber
DC Forward Current (mA) ^[1]	350	350	385
Peak Pulsed Forward Current (mA)	500	500	550
Average Forward Current (mA)	350	350	350
ESD Sensitivity ^[2]	± 16,000V HBM		
LED Junction Temperature (°C)	135	120	120
Aluminum-Core PCB Temperature (°C)	105	105	105
Storage & Operating Temperature (°C)			
LUXEON Star	-40 to +105	-40 to +105	-40 to +105
LUXEON Star/O ^[3]	-40 to +75	-40 to +75	-40 to +75

Notes for Table 7:

1. Proper current derating must be observed to maintain junction temperature below the maximum. For more information, consult the LUXEON Design Guide, available upon request.
2. LEDs are not designed to be driven in reverse bias. Please consult Lumileds' Application Brief AB11 for further information.
3. A reduction in maximum storage and operating temperature is required due to the acrylic optic.

Wavelength Characteristics, $T_J = 25^\circ\text{C}$

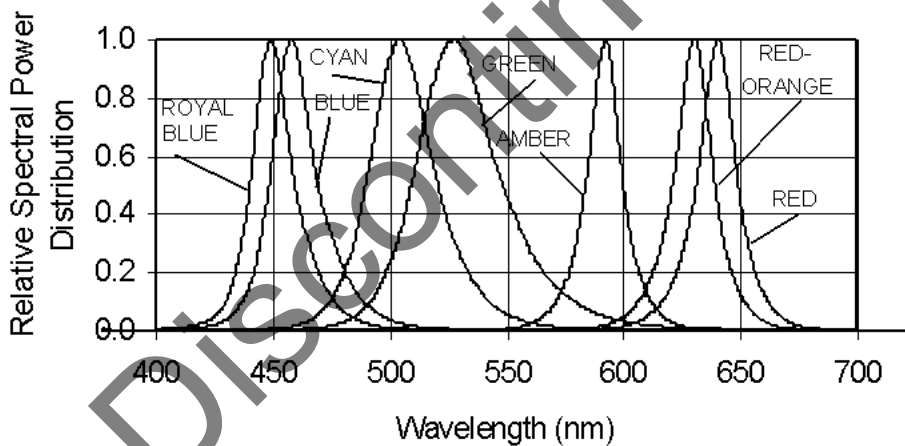

Figure 1a. Relative Intensity vs. Wavelength

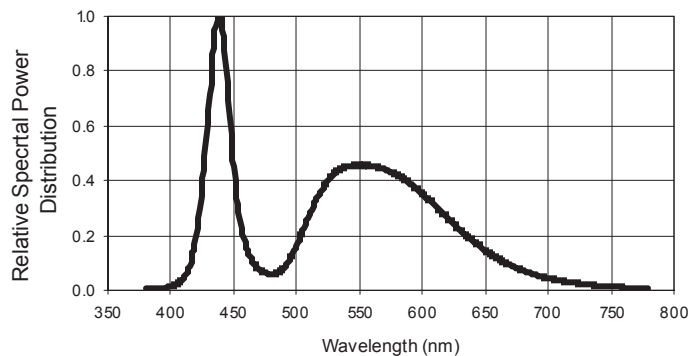

Figure 1b. White Color Spectrum of Typical 5500K Part, Integrated Measurement.

Wavelength Characteristics, $T_J = 25^\circ\text{C}$, Continued

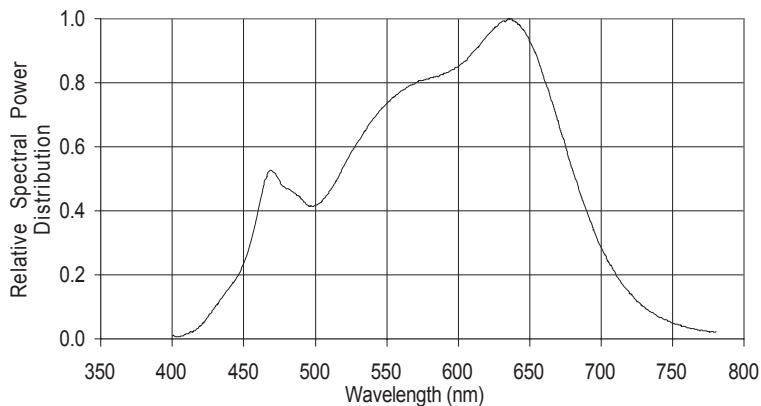

Figure 1c. White Color Spectrum of Typical Warm White Part, Integrated Measurement. Applicable for LXHL-MWGC and LXHL-NWG8.

Light Output Characteristics

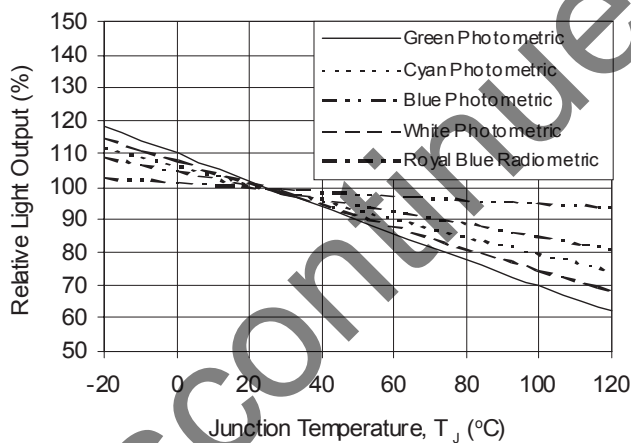

Figure 2a. Relative Light Output vs. Junction Temperature for White, Warm White, Green, Cyan, Blue and Royal Blue.

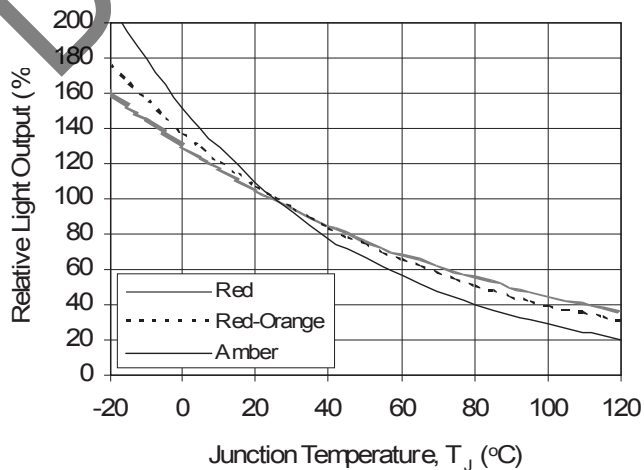

Figure 2b. Relative Light Output vs. Junction Temperature for Red, Red-Orange and Amber.

Forward Current Characteristics, $T_J = 25^\circ\text{C}$

Note:

Driving these high power devices at currents less than the test conditions may produce unpredictable results and may be subject to variation in performance. Pulse width modulation (PWM) is recommended for dimming effects.

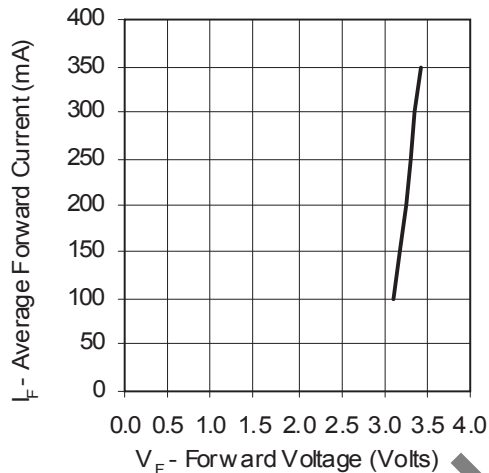

Figure 3a. Forward Current vs. Forward Voltage for White, Warm White, Green, Cyan, Blue, and Royal Blue.

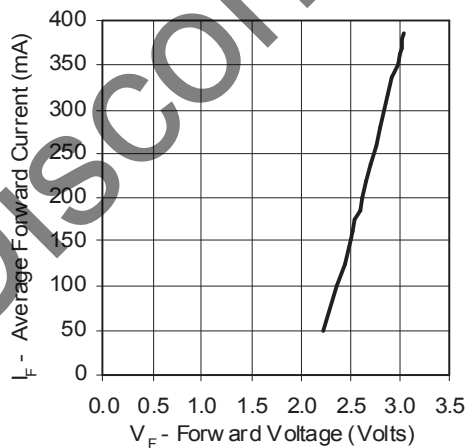

Figure 3b. Forward Current vs. Forward Voltage for Red, Red-Orange and Amber.

Forward Current Characteristics, $T_J = 25^\circ\text{C}$, Continued

Note:

Driving these high power devices at currents less than the test conditions may produce unpredictable results and may be subject to variation in performance. Pulse width modulation (PWM) is recommended for dimming effects.

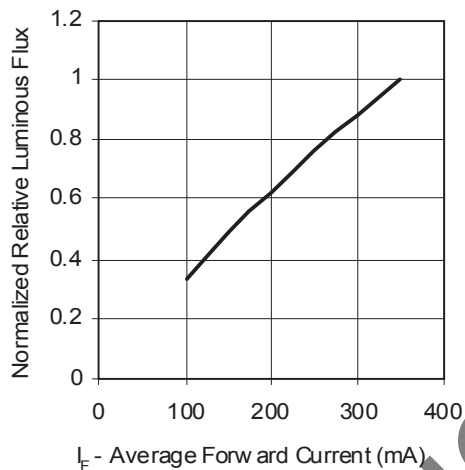

Figure 4a. Relative Luminous Flux vs. Forward Current for White, Warm White, Green, Cyan, Blue, and Royal Blue at $T_J = 25^\circ\text{C}$ maintained.

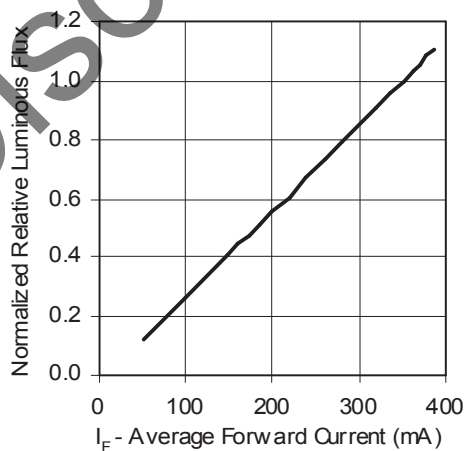

Figure 4b. Relative Luminous Flux vs. Forward Current for Red, Red-Orange and Amber at $T_J = 25^\circ\text{C}$ maintained.

Current Derating Curves Star, Star/C, Star/IDC

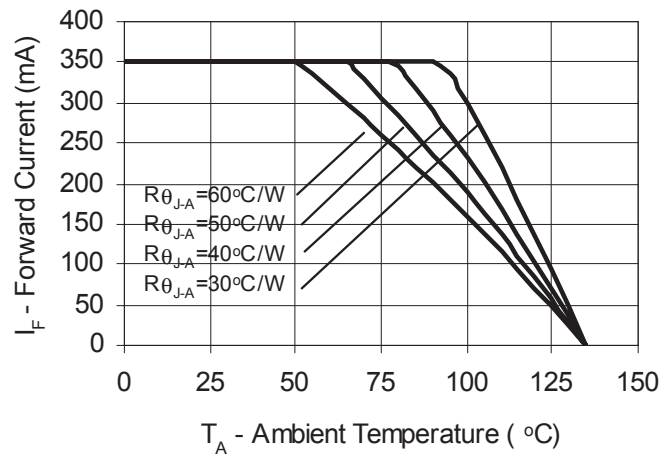

Figure 5a. Maximum Forward Current vs. Ambient Temperature. Derating based on $T_{JMAX} = 135^\circ\text{C}$ for White, Green, Cyan, Blue, and Royal Blue.

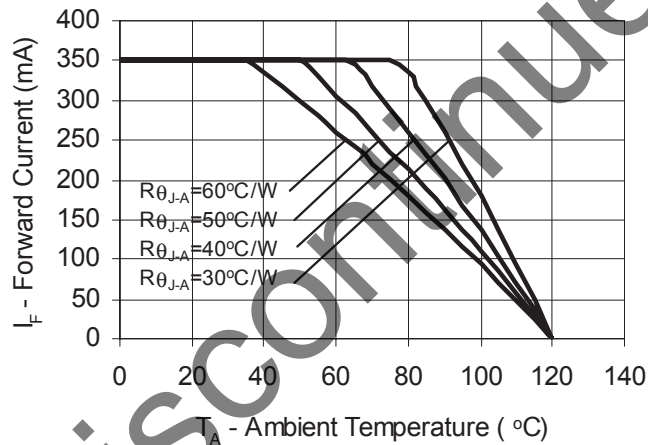

Figure 5b. Maximum Forward Current vs. Ambient Temperature. Derating based on $T_{JMAX} = 120^\circ\text{C}$ for Warm White.

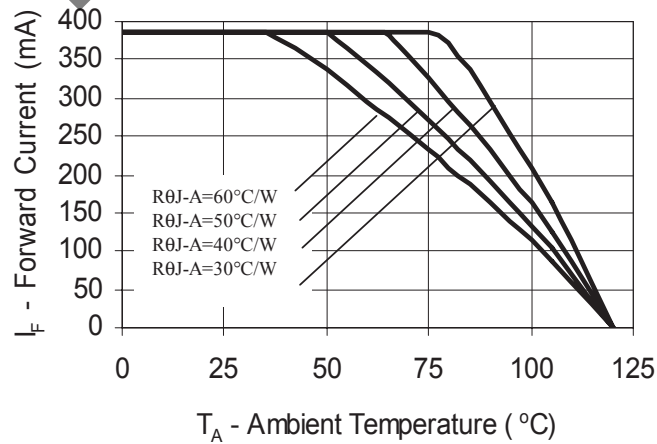

Figure 5c. Maximum Forward Current vs. Ambient Temperature. Derating based on $T_{JMAX} = 120^\circ\text{C}$ for Red, Red-Orange and Amber.

Current Derating Curves Star/O

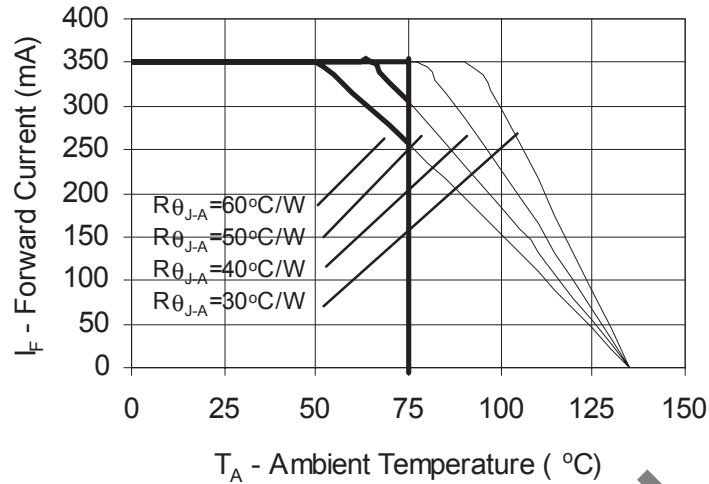

Figure 5d. Maximum Forward Current vs. Ambient Temperature. Derating based on $T_{JMAX} = 135^\circ\text{C}$ and $T_{AMBIENT MAX} = 75^\circ\text{C}$ for White, Green, Cyan, Blue, and Royal Blue.

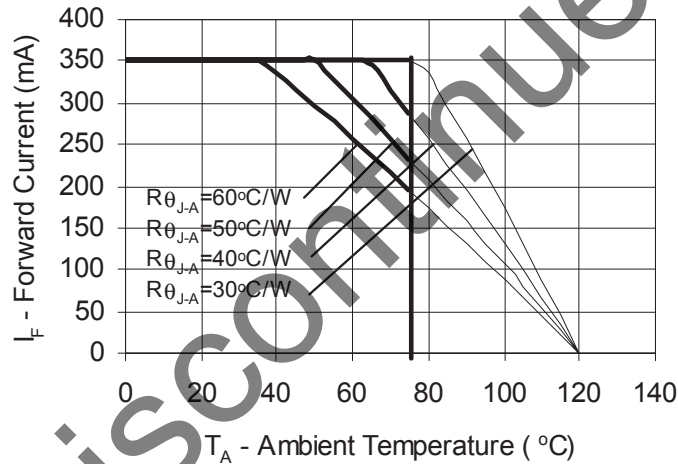

Figure 5e. Maximum Forward Current vs. Ambient Temperature. Derating based on $T_{JMAX} = 120^\circ\text{C}$ and $T_{AMBIENT MAX} = 75^\circ\text{C}$ for Warm White.

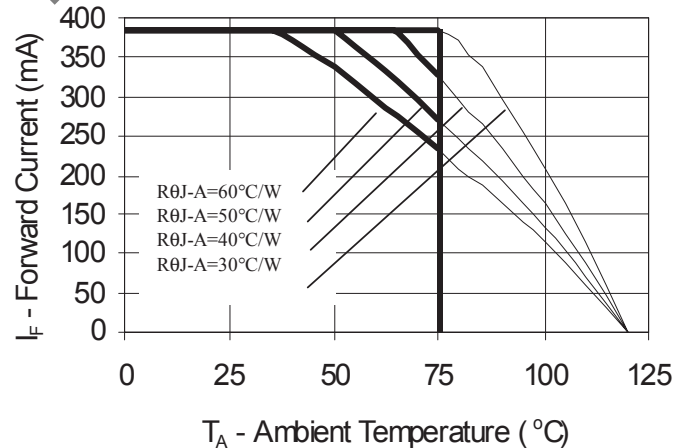

Figure 5f. Maximum Forward Current vs. Ambient Temperature. Derating based on $T_{JMAX} = 120^\circ\text{C}$ and $T_{AMBIENT MAX} = 75^\circ\text{C}$ for Red, Red-Orange and Amber.

Typical Representative Spatial Radiation Pattern

Note:

For more detailed technical information regarding LUXEON radiation patterns, please consult your Lumileds Authorized Distributor or Lumileds sales representative.

Batwing Radiation Pattern (without optics)

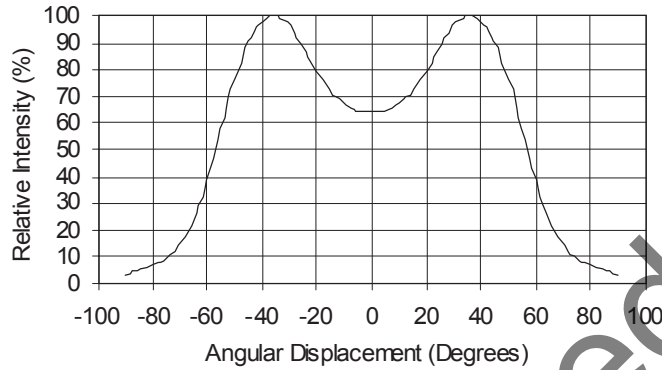

Figure 6a. Typical Representative Spatial Radiation Pattern for LUXEON Star White (LXHL-MW1C, LXHL-MW1A, LXHL-MW1E) and Warm White (LXHL-MWGC).

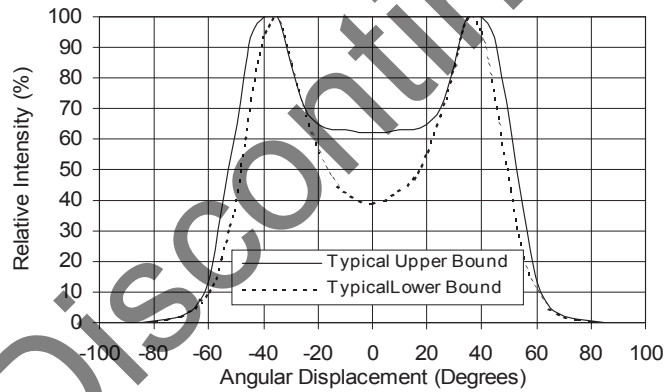

Figure 6b. Typical Representative Spatial Radiation Pattern for LUXEON Star Green, Cyan, Blue, Royal Blue and White.

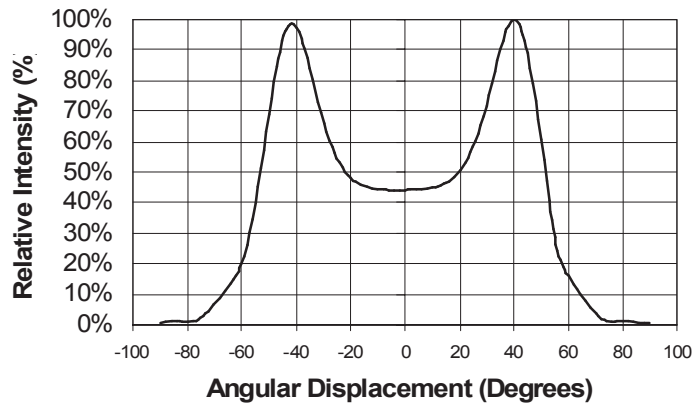

Figure 6c. Typical Representative Spatial Radiation Pattern for LUXEON Star White (LXHL-BW02).

Typical Representative Spatial Radiation Pattern, Continued

Batwing Radiation Pattern (without optics)

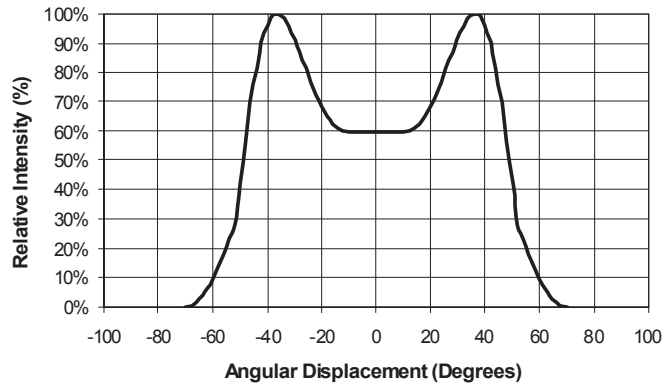

Figure 6d. Typical Representative Spatial Radiation Pattern for LUXEON Star Red and Amber (LXHL-BD01 and LXHL-BL01).

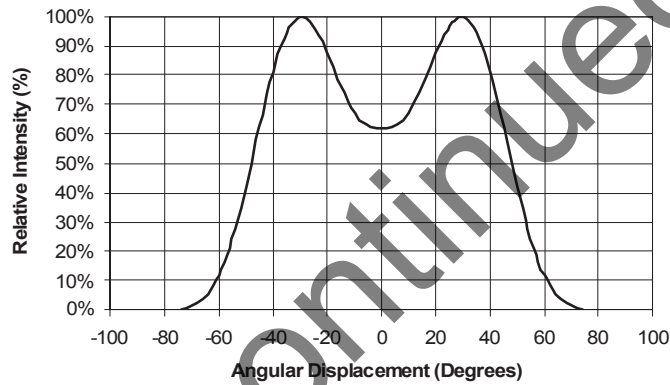

Figure 6e. Typical Representative Spatial Radiation Pattern for LUXEON Star Red, Red-Orange and Amber (LXHL-BD03, BH03 and BL03).

Lambertian Radiation Pattern (without optics)

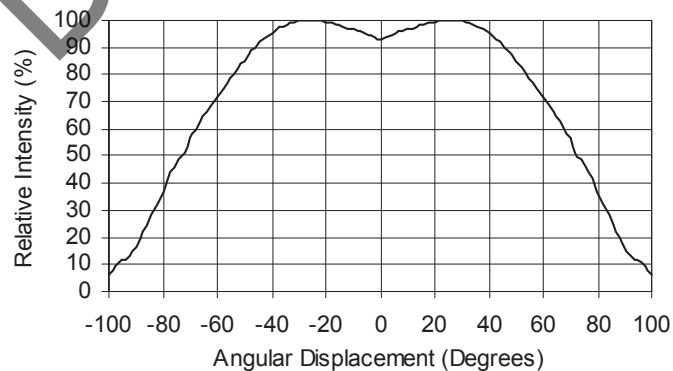

Figure 7a. Typical Representative Spatial Radiation Pattern for LUXEON Star Red, Red-Orange and Amber.

Lambertian Radiation Pattern (without optics), Continued

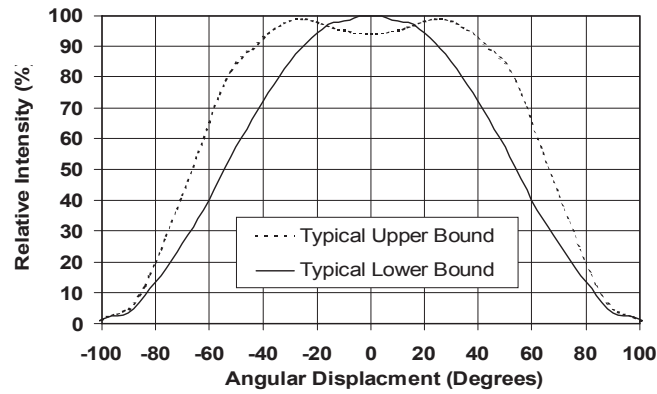

Figure 7b. Typical Representative Spatial Radiation Pattern for LUXEON Star White Green, Cyan, Blue and Royal Blue.

Side Emitting Radiation Pattern (without optics)

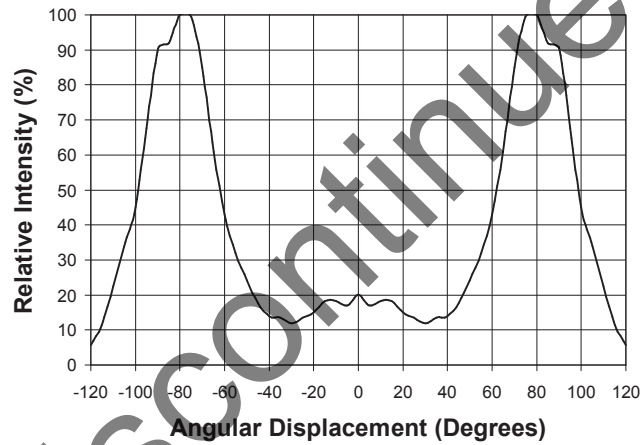

Figure 8a. Typical Representative Spatial Radiation Pattern for LUXEON Star Red, Red-Orange and Amber.

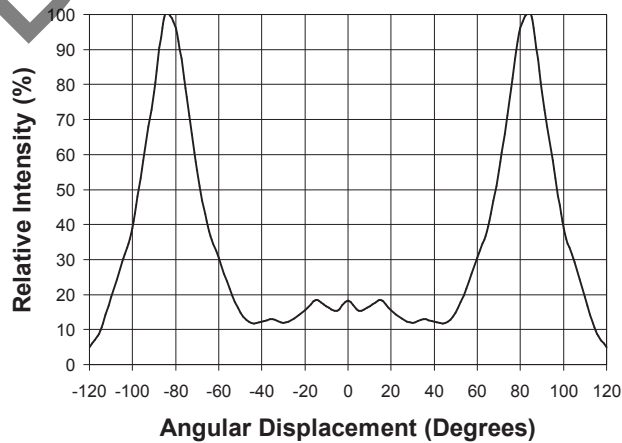

Figure 8b. Typical Representative Spatial Radiation Pattern for LUXEON Star White, Green, Cyan, Blue and Royal Blue.

Radiation Pattern (with optics)

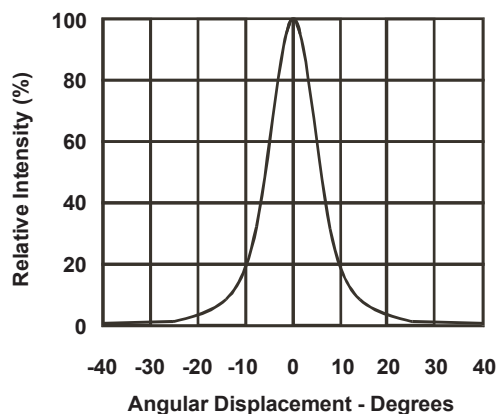

Figure 9. Typical Representative Spatial Radiation Pattern for LUXEON Star/O (with optics), for all colors.

Average Lumen Maintenance Characteristics

Lifetime for solid-state lighting devices (LEDs) is typically defined in terms of lumen maintenance—the percentage of initial light output remaining after a specified period of time. Lumileds projects that LUXEON products will deliver on average 70% lumen maintenance at 50,000 hours of operation. This performance is based on independent test data, Lumileds historical data from tests run on similar material systems, and internal LUXEON reliability testing. This projection is based on constant current 350 mA operation with junction temperature maintained at or below 90°C. Observation of design limits included in this data sheet is required in order to achieve this projected lumen maintenance.

Discontinued

Company Information

LUXEON® is developed, manufactured and marketed by Philips Lumileds Lighting Company. Philips Lumileds is a world-class supplier of Light Emitting Diodes (LEDs) producing billions of LEDs annually. Philips Lumileds is a fully integrated supplier, producing core LED material in all three base colors (Red, Green, Blue) and White. Philips Lumileds has R&D centers in San Jose, California and in The Netherlands and production capabilities in San Jose and Penang, Malaysia. Founded in 1999, Philips Lumileds is the high-flux LED technology leader and is dedicated to bridging the gap between solid-state LED technology and the lighting world. Philips Lumileds technology, LEDs and systems are enabling new applications and markets in the lighting world.

Philips Lumileds may make process or materials changes affecting the performance or other characteristics of our products. These products supplied after such changes will continue to meet published specifications, but may not be identical to products supplied as samples or under prior orders.



WWW.LUXEON.COM
WWW.LUMILEDSFUTURE.COM

FOR TECHNICAL ASSISTANCE OR THE LOCATION OF YOUR NEAREST SALES OFFICE CONTACT ANY OF THE FOLLOWING:

NORTH AMERICA:
+1 888 589 3662 OR
ASKLUXEON@FUTUREELECTRONICS.COM

EUROPE:
OO 800 443 88 873 OR
LUXEON.EUROPE@FUTUREELECTRONICS.COM

ASIA:
800 5864 5337 OR
LUMILEDS.ASIA@FUTUREELECTRONICS.COM