

5.6A, 100V, 0.540 Ohm, N-Channel Power MOSFET

This N-Channel enhancement mode silicon gate power field effect transistor is an advanced power MOSFET designed, tested, and guaranteed to withstand a specified level of energy in the breakdown avalanche mode of operation. All of these power MOSFETs are designed for applications such as switching regulators, switching convertors, motor drivers, relay drivers, and drivers for high power bipolar switching transistors requiring high speed and low gate drive power. These types can be operated directly from integrated circuits.

Formerly developmental type TA17441.

Ordering Information

PART NUMBER	PACKAGE	BRAND
IRF510	TO-220AB	IRF510

NOTE: When ordering, include the entire part number.

Features

- 5.6A, 100V
- $r_{DS(ON)} = 0.540\Omega$
- Single Pulse Avalanche Energy Rated
- SOA is Power Dissipation Limited
- Nanosecond Switching Speeds
- Linear Transfer Characteristics
- High Input Impedance
- Related Literature
 - TB334 "Guidelines for Soldering Surface Mount Components to PC Boards"

Symbol

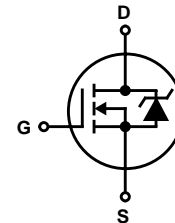

Packaging

JEDEC TO-220AB

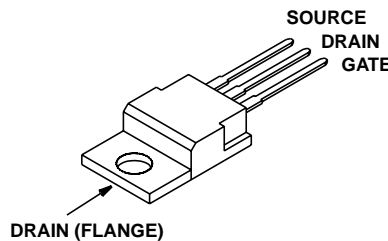

IRF510

Absolute Maximum Ratings $T_C = 25^\circ\text{C}$, Unless Otherwise Specified

	IRF510	UNITS
Drain to Source Voltage (Note 1)	100	V
Drain to Gate Voltage ($R_{GS} = 20\text{k}\Omega$) (Note 1)	100	V
Continuous Drain Current	5.6	A
$T_C = 100^\circ\text{C}$	4	A
Pulsed Drain Current (Note 3)	20	A
Gate to Source Voltage	± 20	V
Maximum Power Dissipation	43	W
Linear Derating Factor	0.29	W/ $^\circ\text{C}$
Single Pulse Avalanche Energy Rating (Note 4)	19	mJ
Operating and Storage Temperature Range	-55 to 175	$^\circ\text{C}$
Maximum Temperature for Soldering		
Leads at 0.063in (1.6mm) from Case for 10s	300	$^\circ\text{C}$
Package Body for 10s, See Techbrief 334	260	$^\circ\text{C}$

CAUTION: Stresses above those listed in "Absolute Maximum Ratings" may cause permanent damage to the device. This is a stress only rating and operation of the device at these or any other conditions above those indicated in the operational sections of this specification is not implied.

NOTE:

1. $T_J = 25^\circ\text{C}$ to 150°C .

Electrical Specifications $T_C = 25^\circ\text{C}$, Unless Otherwise Specified

PARAMETER	SYMBOL	TEST CONDITIONS	MIN	TYP	MAX	UNITS
Drain to Source Breakdown Voltage	BV_{DSS}	$V_{GS} = 0\text{V}$, $I_D = 250\mu\text{A}$, (Figure 10)	100	-	-	V
Gate to Threshold Voltage	$V_{GS(TH)}$	$V_{GS} = V_{DS}$, $I_D = 250\mu\text{A}$	2.0	-	4.0	V
Zero-Gate Voltage Drain Current	I_{DSS}	$V_{DS} = 95\text{V}$, $V_{GS} = 0\text{V}$	-	-	25	μA
		$V_{DS} = 0.8 \times \text{Rated } BV_{DSS}$, $V_{GS} = 0\text{V}$, $T_J = 150^\circ\text{C}$	-	-	250	μA
On-State Drain Current (Note 2)	$I_{D(ON)}$	$V_{DS} > I_{D(ON)} \times r_{DS(ON)MAX}$, $V_{GS} = 10\text{V}$ (Figure 7)	5.6	-	-	A
Gate to Source Leakage Current	I_{GSS}	$V_{GS} = \pm 20\text{V}$	-	-	± 100	nA
Drain to Source On Resistance (Note 2)	$r_{DS(ON)}$	$V_{GS} = 10\text{V}$, $I_D = 3.4\text{A}$ (Figures 8, 9)	-	0.4	0.54	Ω
Forward Transconductance (Note 2)	g_{fs}	$V_{GS} = 50\text{V}$, $I_D = 3.4\text{A}$ (Figure 12)	1.3	2.0	-	S
Turn-On Delay Time	$t_{d(ON)}$	$I_D = 5.6\text{A}$, $R_{GS} = 24\Omega$, $V_{DD} = 50\text{V}$, $R_L = 9\Omega$, $V_{DD} = 50\text{V}$, $V_{GS} = 10\text{V}$ MOSFET switching times are essentially independent of operating temperature	-	8	12	ns
Rise Time	t_r		-	25	63	ns
Turn-Off Delay Time	$t_{d(OFF)}$		-	15	7	ns
Fall Time	t_f		-	12	59	ns
Total Gate Charge (Gate to Source + Gate to Drain)	$Q_{g(TOT)}$	$V_{GS} = 10\text{V}$, $I_D = 5.6\text{A}$, $V_{DS} = 0.8 \times \text{Rated } BV_{DSS}$, $I_{G(REF)} = 1.5\text{mA}$ (Figure 14)	-	5.0	30	nC
Gate to Source Charge	Q_{gs}	Gate charge is essentially independent of operating temperature.	-	2.0	-	nC
Gate to Drain "Miller" Charge	Q_{gd}		-	3.0	-	nC
Input Capacitance	C_{ISS}	$V_{GS} = 0\text{V}$, $V_{DS} = 25\text{V}$, $f = 1.0\text{MHz}$ (Figure 11)	-	135	-	pF
Output Capacitance	C_{OSS}		-	80	-	pF
Reverse-Transfer Capacitance	C_{RSS}		-	20	-	pF
Internal Drain Inductance	L_D	Measured From the Contact Screw On Tab To Center of Die	-	3.5	-	nH
		Measured From the Drain Lead, 6mm (0.25in) From Package to Center of Die	-	4.5	-	nH
Internal Source Inductance	L_S	Measured From The Source Lead, 6mm (0.25in) From Header to Source Bonding Pad	-	7.5	-	nH
Junction to Case	$R_{\theta JC}$		-	-	3.5	$^\circ\text{C/W}$
Junction to Ambient	$R_{\theta JA}$	Free air operation	-	-	80	$^\circ\text{C/W}$

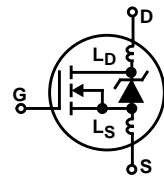

Source to Drain Diode Specifications

PARAMETER	SYMBOL	Test Conditions	MIN	TYP	MAX	UNITS
Continuous Source to Drain Current	I_{SD}	Modified MOSFET Symbol Showing the Integral Reverse P-N Junction Diode	-	-	5.6	A
Pulse Source to Drain Current (Note 3)	I_{SDM}		-	-	20	A
Source to Drain Diode Voltage (Note 2)	V_{SD}	$T_J = 25^{\circ}\text{C}$, $I_{SD} = 5.6\text{A}$, $V_{GS} = 0\text{V}$ (Figure 13)	-	-	2.5	V
Reverse Recovery Time	t_{rr}	$T_J = 25^{\circ}\text{C}$, $I_{SD} = 5.6\text{A}$, $dI_{SD}/dt = 100\text{A}/\mu\text{s}$	4.6	96	200	ns
Reverse Recovered Charge	Q_{RR}	$T_J = 25^{\circ}\text{C}$, $I_{SD} = 5.6\text{A}$, $dI_{SD}/dt = 100\text{A}/\mu\text{s}$	0.17	0.4	0.83	μC

NOTES:

2. Pulse test: pulse width $\leq 300\mu\text{s}$, duty cycle $\leq 2\%$.
3. Repetitive rating: pulse width limited by max junction temperature. See Transient Thermal Impedance curve (Figure 3).
4. $V_{DD} = 25\text{V}$, start $T_J = 25^{\circ}\text{C}$, $L = 910\mu\text{H}$, $R_G = 25\Omega$, peak $I_{AS} = 5.6\text{A}$.

Typical Performance Curves Unless Otherwise Specified

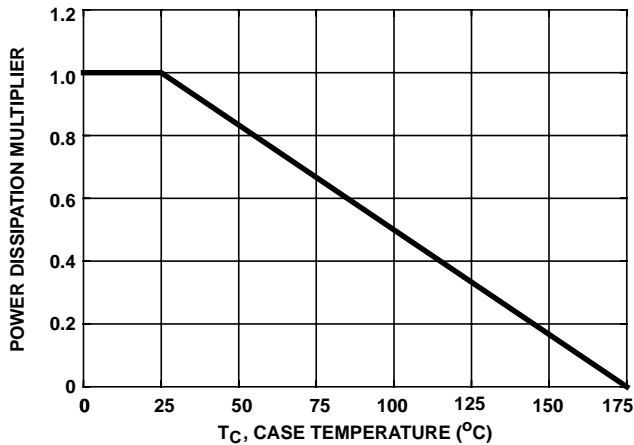

FIGURE 1. NORMALIZED POWER DISSIPATION vs CASE TEMPERATURE

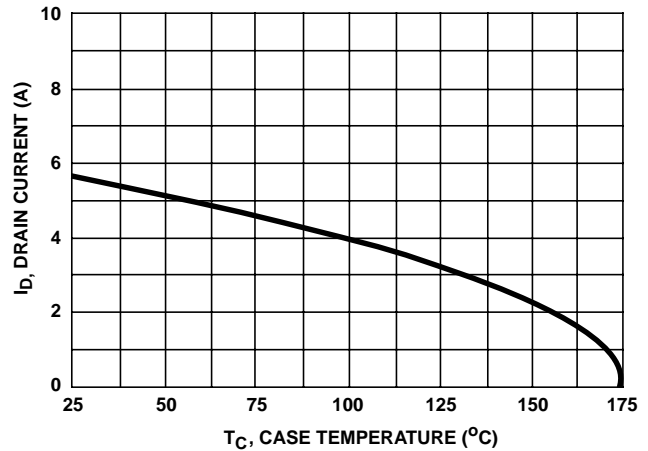

FIGURE 2. MAXIMUM CONTINUOUS DRAIN CURRENT vs CASE TEMPERATURE

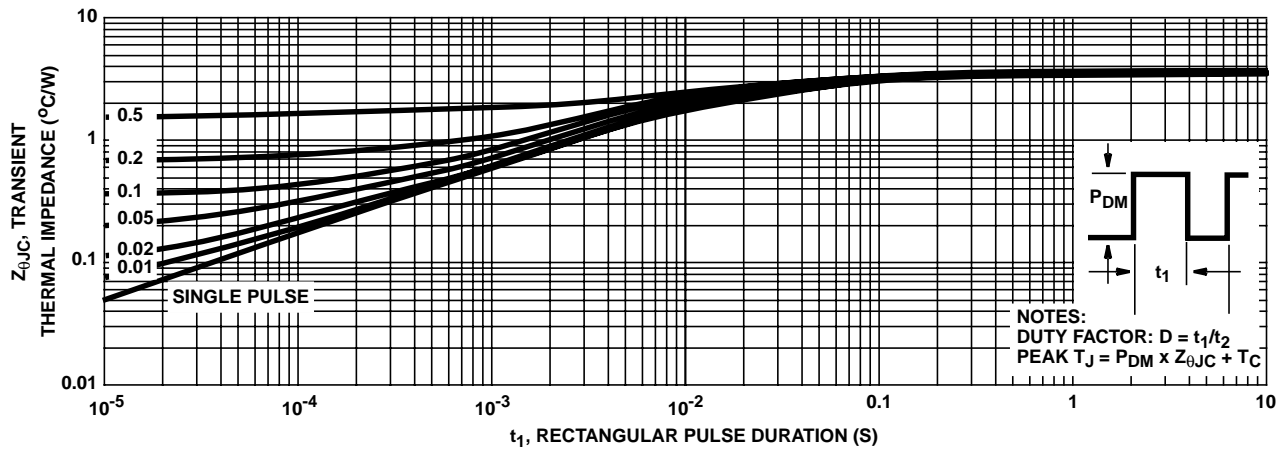

FIGURE 3. MAXIMUM TRANSIENT THERMAL IMPEDANCE

Typical Performance Curves Unless Otherwise Specified (Continued)

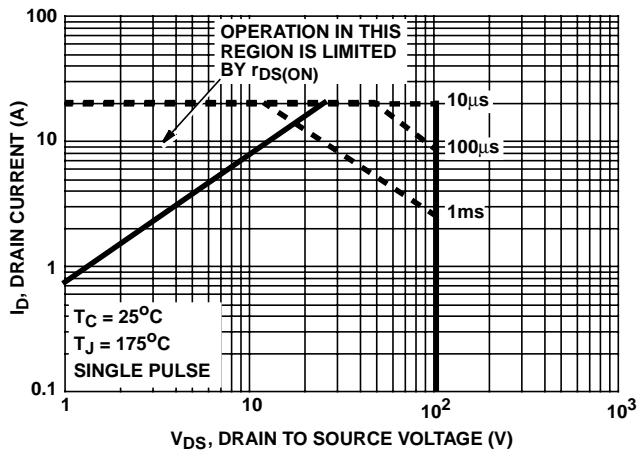

FIGURE 4. FORWARD BIAS SAFE OPERATING AREA

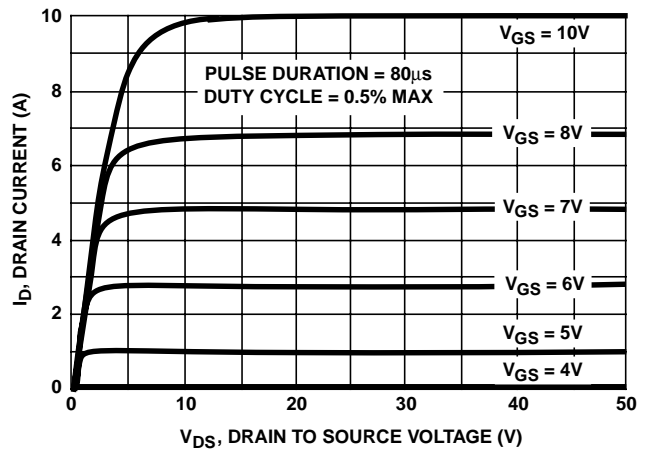

FIGURE 5. OUTPUT CHARACTERISTICS

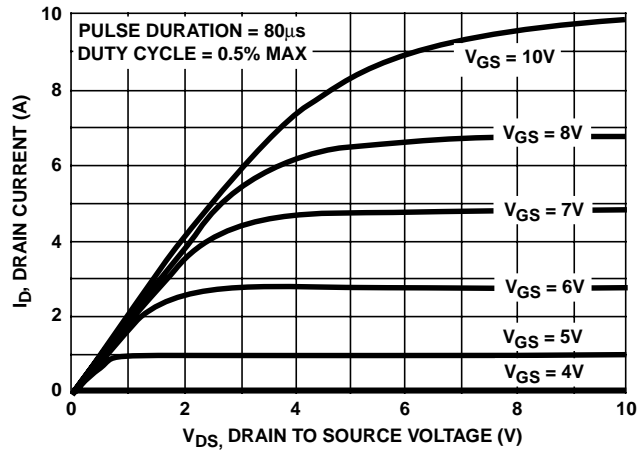

FIGURE 6. SATURATION CHARACTERISTICS

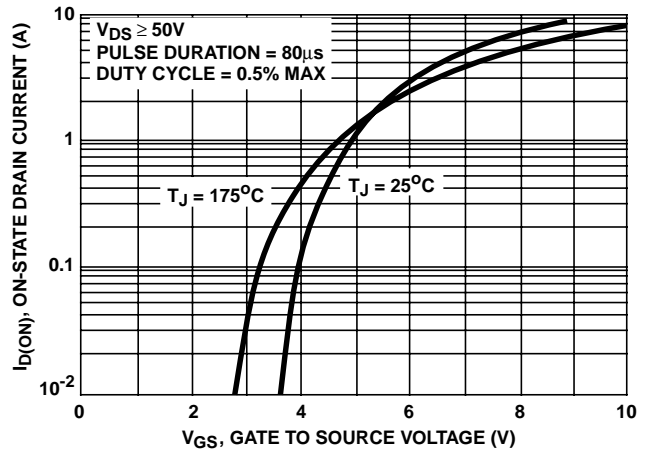

FIGURE 7. TRANSFER CHARACTERISTICS

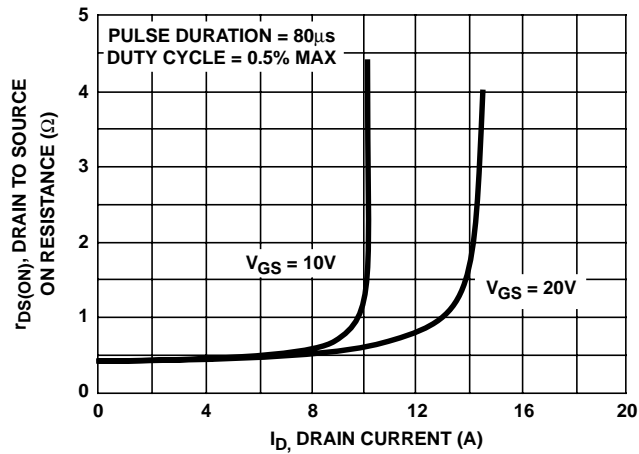

FIGURE 8. DRAIN TO SOURCE ON RESISTANCE vs GATE VOLTAGE AND DRAIN CURRENT

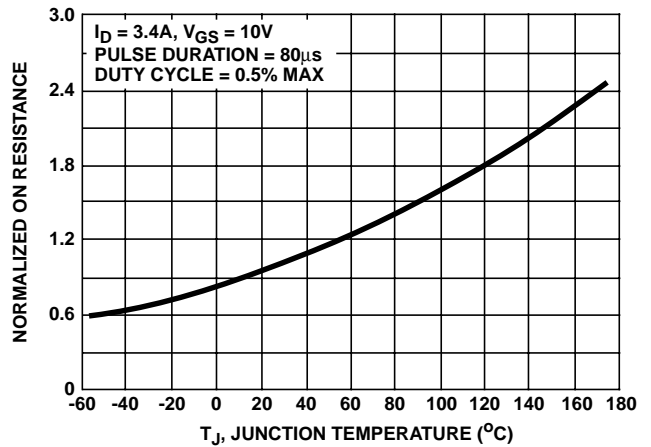

FIGURE 9. NORMALIZED DRAIN TO SOURCE ON RESISTANCE vs JUNCTION TEMPERATURE

Typical Performance Curves Unless Otherwise Specified (Continued)

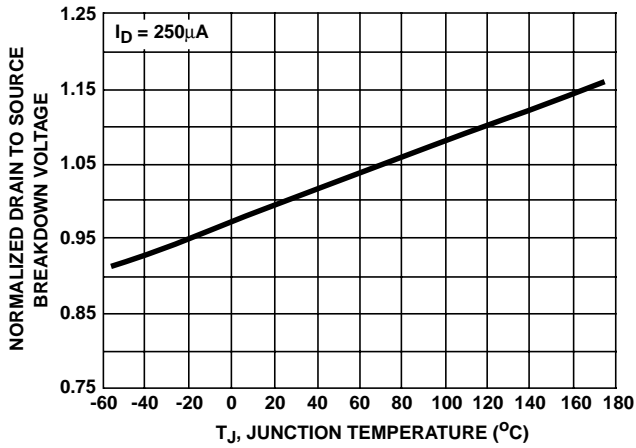

FIGURE 10. NORMALIZED DRAIN TO SOURCE BREAKDOWN VOLTAGE vs JUNCTION TEMPERATURE

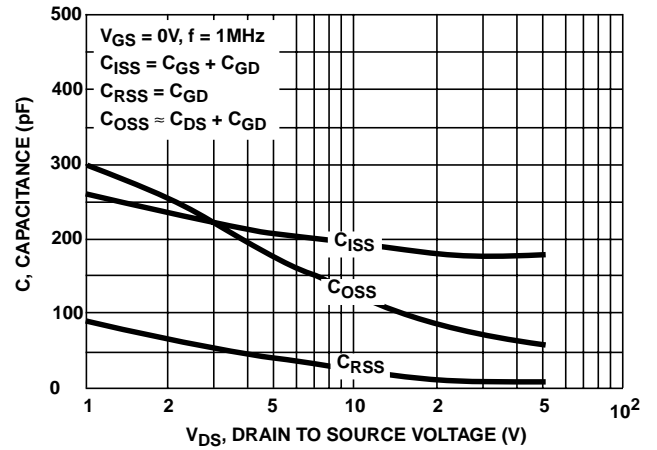

FIGURE 11. CAPACITANCE vs DRAIN TO SOURCE VOLTAGE

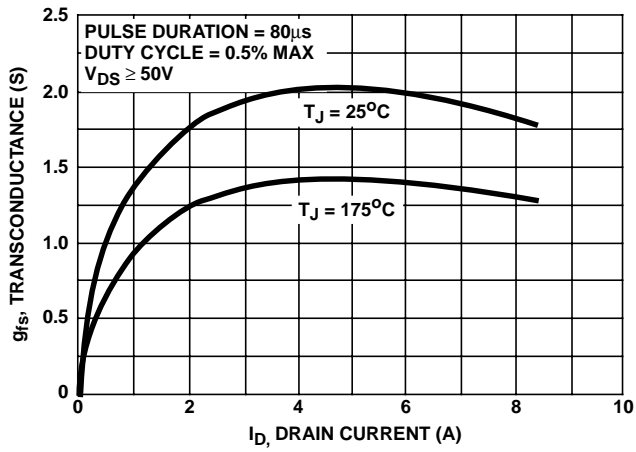

FIGURE 12. TRANSCONDUCTANCE vs DRAIN CURRENT

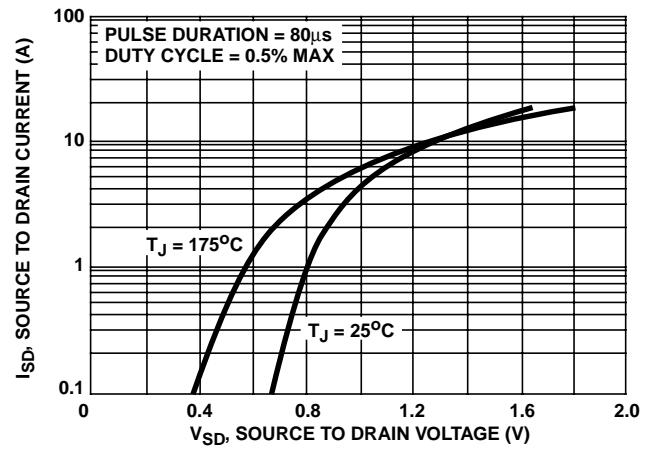

FIGURE 13. SOURCE TO DRAIN DIODE VOLTAGE

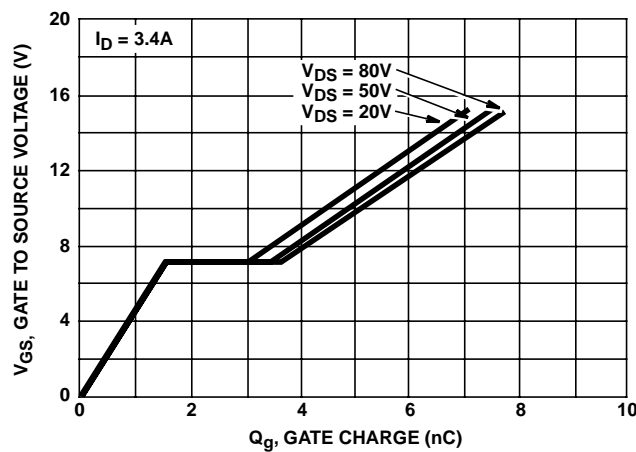

FIGURE 14. GATE TO SOURCE VOLTAGE vs GATE CHARGE

Test Circuits and Waveforms

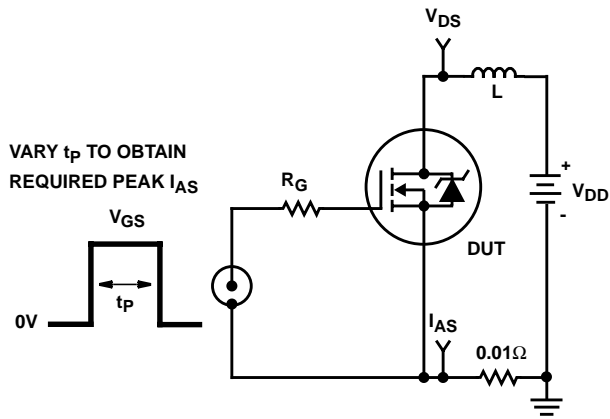

FIGURE 15. UNCLAMPED ENERGY TEST CIRCUIT

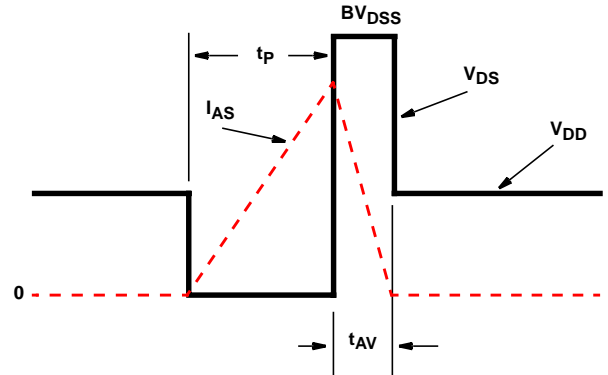

FIGURE 16. UNCLAMPED ENERGY WAVEFORMS

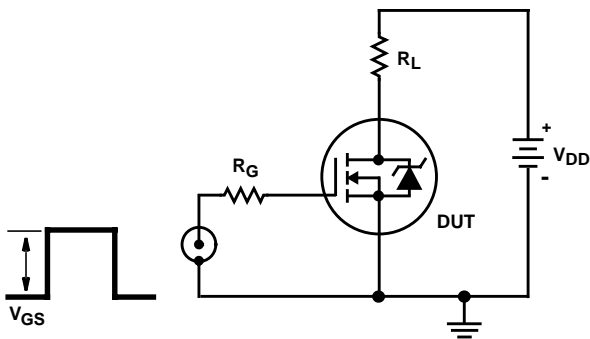

FIGURE 17. SWITCHING TIME TEST CIRCUIT

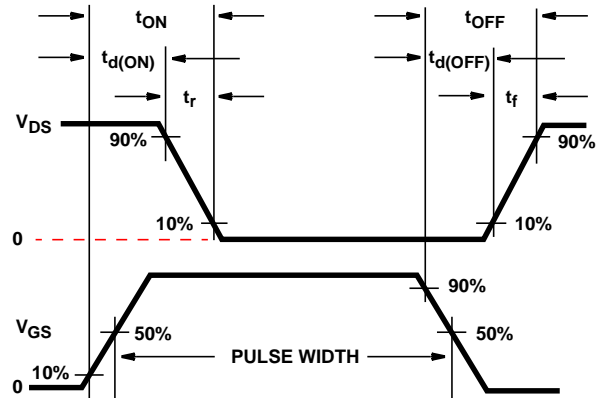

FIGURE 18. RESISTIVE SWITCHING WAVEFORMS

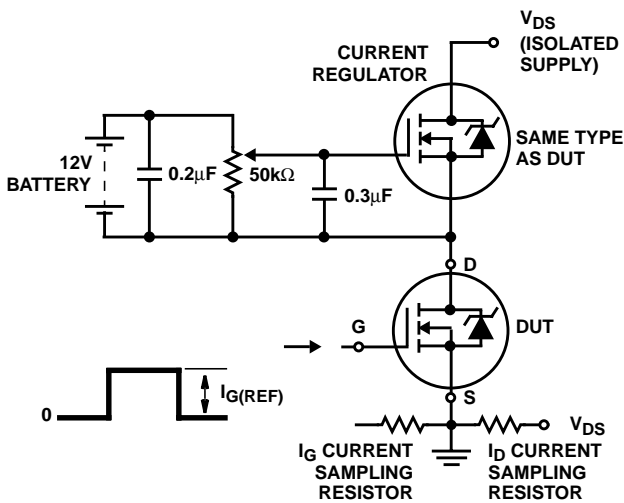

FIGURE 19. GATE CHARGE TEST CIRCUIT

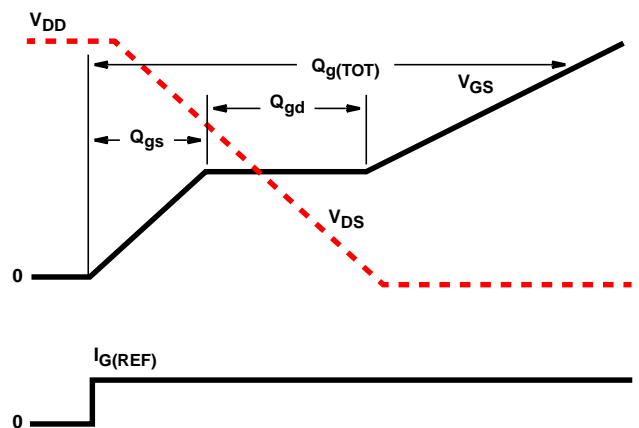

FIGURE 20. GATE CHARGE WAVEFORM

All Intersil semiconductor products are manufactured, assembled and tested under **ISO9000** quality systems certification.

Intersil semiconductor products are sold by description only. Intersil Corporation reserves the right to make changes in circuit design and/or specifications at any time without notice. Accordingly, the reader is cautioned to verify that data sheets are current before placing orders. Information furnished by Intersil is believed to be accurate and reliable. However, no responsibility is assumed by Intersil or its subsidiaries for its use; nor for any infringements of patents or other rights of third parties which may result from its use. No license is granted by implication or otherwise under any patent or patent rights of Intersil or its subsidiaries.

For information regarding Intersil Corporation and its products, see web site <http://www.intersil.com>

Sales Office Headquarters

NORTH AMERICA

Intersil Corporation
P. O. Box 883, Mail Stop 53-204
Melbourne, FL 32902
TEL: (407) 724-7000
FAX: (407) 724-7240

EUROPE

Intersil SA
Mercure Center
100, Rue de la Fusee
1130 Brussels, Belgium
TEL: (32) 2.724.2111
FAX: (32) 2.724.22.05

ASIA

Intersil (Taiwan) Ltd.
7F-6, No. 101 Fu Hsing North Road
Taipei, Taiwan
Republic of China
TEL: (886) 2 2716 9310
FAX: (886) 2 2715 3029

This datasheet has been downloaded from:

www.DatasheetCatalog.com

Datasheets for electronic components.